

# Directory of SATSA Members

Iranian Industrial  
Equipment Manufacturers  
Association  
(SATSA)

2019 



In the name of God



**SATSA's Profile Book**

**Iranian Industrial Equipment Manufacturers Association  
(SATSA)**

*Managed by:*  
**Abdol aziz Hedayat  
Ahad Zolrahmi**

*Created by:*  
**Maryam Shokatpour  
Nasim Afsari**

*Designed by:*  
**Ali Akbar Darigh**

**2019**

## INDEX

■ SATSA Members of the Board .....	5
■ Vision .....	6
■ About SATSA .....	6
■ Field of Members Activities .....	7
■ Guide of SATSA Members Information .....	8
■ SATSA Members Information .....	11
■ Glossary .....	183
■ Guide of Other SATSA Members .....	208
■ Other SATSA Members .....	209

## SATSA Members of the Board



A. Hedayat



A. Ekhteraei



A. Parvin



M. H. Bassiri



M.B. Tajrishi



J. Safari



A. Jahani

## Message

SATSA is the Iranian Industrial Equipment Manufacturers association. This catalog presents the capabilities of SATSA members and their references as well as their contacts and attributes.

In this catalog, products and services provided by all SATSA members will be explored. For further information regarding each member, you may refer to their website or contact them directly.

The range of products and services supplied by SATSA members includes a variety of industrial demands including Oil and Gas, Petrochemical, Power, Water, Steel, Cement and etc.

Industrial equipment manufacturing in Iran has developed significantly within recent decades, so much so that almost all currently manufactured products by SATSA members have suitable quality in accordance to API and/or European/ Iranian Standards.

SATSA members have acquired the infrastructure and capacity to support not only the Iranian markets for the specified fields, but also to export their qualitative products to overseas markets.

For best use of this catalog, users can refer to the table of contents to search for company names or use the glossary to find Iranian suppliers for each equipment and industry they may require.

SATSA's catalog is scheduled to publish annually and can be found at [www.SATSA.ir](http://www.SATSA.ir) or through SATSA headquarters.



### Vision:

Developing of opportunities for localization & technological Improves along with International & local markets & Relation for Iranian Industrial equipment Munufacturer

### About SATSA:

SATSA  
Iranian Industrial Equipment Manufacturers Association

Iranian industrial Equipment Manufacturers Association was found in Aug. 1989 based on requirement of developing and improving industrial and projects. SATSA Association is looking forward to reach the following goals.

- Developing Export (members products)
- Training
- Research
- Quality Improvement
- Technology Transfer
- Developing Foreign Relationship (Between members & international companies)

### Field of Members Activities

#### Fixed Equipment

- Pressure Vessels & Tanks
- Heat Exchangers
- Steel Structures
- Offshore Facilities & Platforms
- Piping
- Filter & Seperation Equipments
- ...

#### Rotary Equipment

- Gas Turbines & Turbo Compressors
- Utility & Process Pumps (API/ Non-API)
- Drilling Equipment & Accessories

#### Process Equipment

- Packages (Chemical Injection, Wate Desalination, Polishing & ...)
- Reformers
- Towers & Internals
- Heat Exchangers

#### Port Handling & Rail Way

- Rail Way Equipment
- Cranes

#### Special Equipment

- Glass Lined Equipment
- Fluoropolymer Accessories
- FRP & GRP Piping & Tanks
- Coated Pipe & Lining
- ...



Oil Gas & Petrochemical



Chemical, Food & Medicine



Mining



Energy



Water & Wastewater

## Guide of SATSA Members Information

Name of Company	Page
<b>A</b>	
Aban Air Cooler	12
Aban Innovative Technologies Group Co.	14
Aliaj Joosh Aria	16
Aria Rockwool Company	18
Arta Sanat Arsen	20
Arvin Sanat Apadana Co.	22
Arya Seal Part	24
Asto Machine and Industrial Structure Manufacturing Co.	26
Azarab Industries Co.	28
<b>B</b>	
Behesht Kavir Ariana	30
<b>C</b>	
Centigrade Ind. Inc.	32
Chamaan Engineering and Fabrication	34
<b>D</b>	
Daboo Sanat Co.	36
Damafin Thermal Technology Co.	38
Deylaman Filter	40
<b>E</b>	
Ebdaagaran Padide Knowledge-based Company	42
Esfahan Machinery Manufacturing Company	44
Euroslot Pars	46
<b>F</b>	
Fakoor Meghnatis Spadana Co.	48
Farab	50
Faradid Meehan Engineering Company	52
Farapishtaz Hoonam Rubber Industries	54
Farayand Bokhar	56
Farineh Machine	58
Fars Afzar Kimiya Co.	60
Fateh Sanat Kimia	62
Foolad Paya Engineering Co.	64
<b>G</b>	
Garma Gostar (Energy Engineering)	66

## Guide of SATSA Members Information

Name of Company	Page
<b>H</b>	
Hava Filter	68
Heavy Duty Pumps and Water (Turbine M.F.G. Co.)	70
<b>I</b>	
Industrial Pioneers Farayand	72
Interlock Co. (Industrial Turn-key Groups)	74
<b>J</b>	
Jahan Ayegh Pars	76
Jahankar Esfahan	78
<b>K</b>	
Kaveh Mobadel	80
Kavosh Sanat Toos	82
Kimiagaran Sanat Pars Co.	84
Klevers Aryana	86
<b>M</b>	
Machine Roll Co.	88
Machine Ajza Co.	90
Machine Rood Pars Arak	92
Machine Sazi Arak Co. Knowledge - Based Company	94
Mahdin Industrial Company	96
Mahshahr Pipe Protection Co.	98
Mangan Manufacturing Company	100
Mapna Boiler & Equipment Engineering and Manufacturing Co.	102
Mapna STS Co.	104
Mapna Turbine Engineering & Manufacturing Co. (TUGA)	106
Mashal Kaveh	108
Masnouat Felezi Sangin	110
Momtaz Pump Co.	112
<b>N</b>	
Navid Sahand Pump Manufacturing Industries Co.	114
Niroumoharekeh Machine tools Co.	116
<b>O</b>	
Omran Tahviah Co.	118

## Guide of SATSA Members Information

Name of Company	Page
<b>P</b>	
Packman Company	120
Pakfanbokhar	122
Pantan	124
Pars Sealing Systems Company (Burgmann Pars)	126
Pars Vacuum Industries	128
Pars Zagros Heavy Machinery Co.	130
Paya Sanat Ahwaz	132
Paysaz Co.	134
Petro Foolad Jahan Co.	136
Petro Pump Engineering Design and Manufacture	138
Petrochemical Industries Design Equipment & Parts Manufacture Company	140
Piramoons System Qeshm	142
Poolad Varzan-E- Kimia Co.	144
Production Picture Of Iran	146
Pumpiran	148
<b>Q</b>	
Qeshm Offshore Free Ports & Industries	150
<b>R</b>	
RadIran Mfg. Co.	152
Rasta Group (Industrial Valve MFG & DEV Co.)	154
Rased Sanat Toseae	156
<b>S</b>	
Sabz Ashian APadana Eng. Co. (SAAPEC)	158
Sadid Industrial Group	160
Salafchegan Pipe and Protection Co.	162
Sanat Karan Bermy Co.	164
Sanat yaran Co.	166
Sazvar Sazeh Azarestan	168
Shimi Azarjam	170
<b>T</b>	
Tasha Manufacturing Co.	172
Tavan Mehvar azin sanat	174
Tghtiran Kashan Co.	176
Turbinedar	178
<b>Y</b>	
Yekta Tahviah Arvand IND	180

## SATSA Members Information



## Aban Air Cooler

Founded date: 1998 / 01 / 11  
Office & workshop area: 105,000 m2  
Number of Staff: 423



### Products / Services:



Air Cooled Heat Exchanger  
ODCC



Air Cooled Condenser  
Parand



Helical Shell and Tube Heat Exchanger  
Boushehr



Shell and Tube Heat Exchanger  
Boushehr



Pressure Vessels  
Boushehr



Recuperator (For Steel Complex)  
Foulad Mobarakeh

### Products / Services:



Combined Cycle and Steam Power Plant  
Yazd



INDIRECT COOLING (Auxiliary Cooling)  
Power Plants

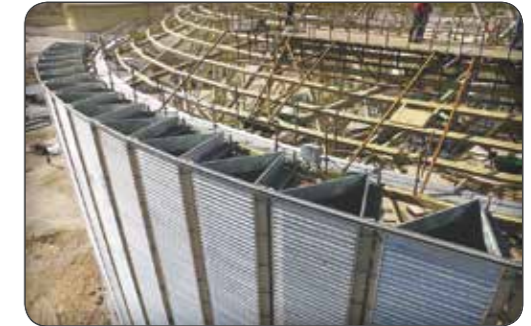

DIRECT COOLING  
(Gas Power Plants, Fin-Fan Coolers (Water/Lube Coolers))  
Tana Energy



Water refrigeration package  
Different places



Fin tubes  
Different places

Tel: +98 7136433000  
Fax: +98 7136433033  
E-mail: [info@abanaircooler.com](mailto:info@abanaircooler.com)  
Web: [www.abanaircooler.com](http://www.abanaircooler.com)  
Address: Km2, Second Entrance of Sadra Town,  
Shiraz, Iran



Refrigeration Packages  
Different places

## Aban Innovative Technologies Group Co.

Founded date: 2013 / 10 / 13  
Office & workshop area: 5,724 m<sup>2</sup>  
Number of Staff: 141



### Products / Services:



Air Cooled Condenser (ACC): It's a system used for cooling of steam in the Thermal Power, Oil, Gas and Petrochemical Plants. In this system, steam enters in vacuum/half vacuum condition, and is distilled and exits as saturated water. Vacuum pressure is a critical parameter to consider during the design procedure.  
(Parand Power Plant)

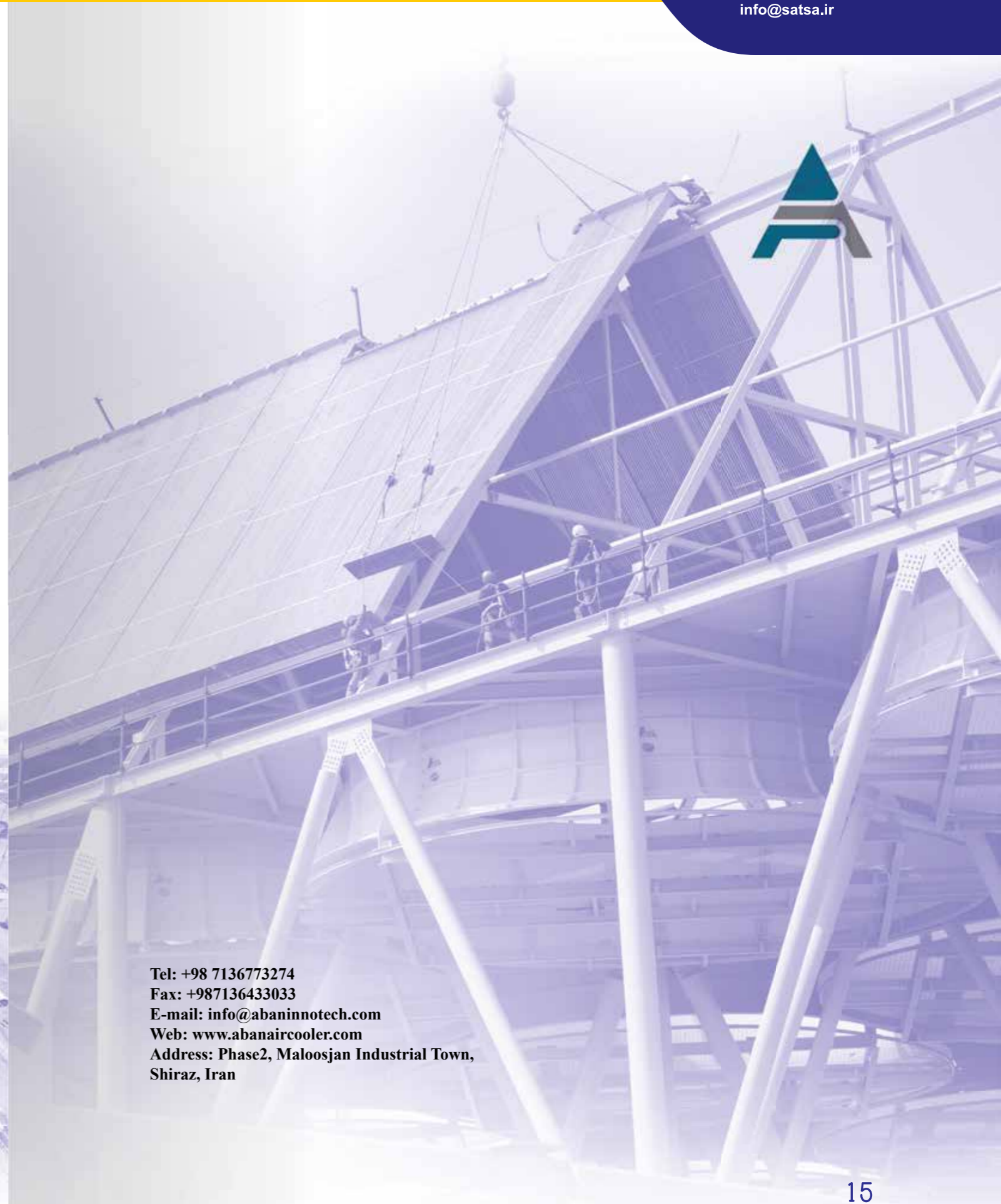
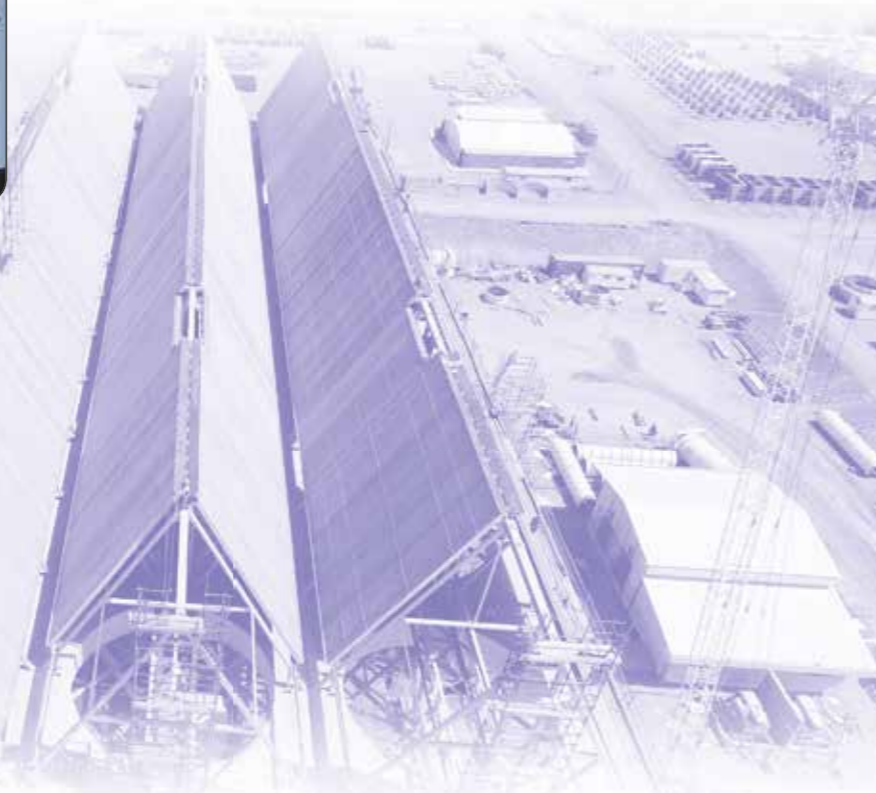

Tel: +98 7136773274  
Fax: +987136433033  
E-mail: [info@abaninnotech.com](mailto:info@abaninnotech.com)  
Web: [www.abanaircooler.com](http://www.abanaircooler.com)  
Address: Phase2, Maloosjan Industrial Town,  
Shiraz, Iran



## Aliaj Joosh Aria

Founded date: 2001 / 07 / 14  
Office & workshop area: 14810 m2  
Number of Staff: 150



### Products / Services:



Cladding in wellhead equipment  
Cladding in Pressure Vessels, Towers, Heat Exchangers, ...  
Cladding in Pipeline and Piping Systems  
Cladding in all types of Flange and Fitting  
Production and Supplying of Welding Consumable

Tel: +98 21 88715528 - 29  
Fax: +98 21 88705510  
E-mail: [ahmad.karimi@aliaj-joosh.com](mailto:ahmad.karimi@aliaj-joosh.com)  
Web: [www.aliaj-joosh.com](http://www.aliaj-joosh.com)  
Address: No.20, Azadegan Alley, Qaem Magham Farahani St., Tehran – Iran

## Aria Rockwool Company

Founded date: 2007 / 07 / 11  
Office & workshop area: 20,200 m2  
Number of Staff: 100



### Products / Services:



Rockwool insulation classified as hot insulation with efficient thermal performance in wide temperature range of 30~850°C.



Rock Wool Blanket Insulation is used for equipment and curve surface and high temperature applications.



Rock wool Pipe insulation is suitable for insulating pipelines in hot temperature up to 650°C.



Rockwool panel insulation is used as acoustic and thermal insulation specially in buildings Up to 500°C



PIR cold insulation is used in cryogenic systems for Pipelines and equipment (-196 ~ 140 C.)

### Products / Services:



PIR preformed insulation (panel and pipe section) is shaped by CNC in different size and thickness.



Injection foam insulation (Poly+Iso) is used for insulating complex and inaccessible surfaces.



PIR Spry insulation is used for building and industrial structures and equipment for low temperatures.

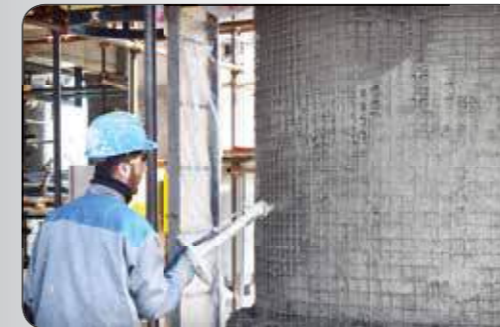

Aria FP100 is cement base material which protect concrete and steel structures against fire 1-4 hr.



Mastic FS80 (adhesive sealant) is used to stick the insulation components to each other for sealing.

Tel: +98 32231770  
Fax: +98 32231770 - ext. 602  
E-mail: info@ariarockwool.ir  
Web: www.ariarockwool.ir  
Address: No 2, Hafez Building, Felestin St,  
Felestin crossroad,  
Isfahan, Iran



Mastic FS60-90 is used as vapor barrier to protect insulation surface against moisture, dust, ...

## ARTA SANAT ARSEN

Founded date: 2013 / 12 / 11  
Office & workshop area: 500 m<sup>2</sup>  
Number of Staff: 15



### Products / Services:



Single Mechanical Seal



Double Mechanical Seal



Cartex Mechanical Seal



Multi Spring Mechanical Seal

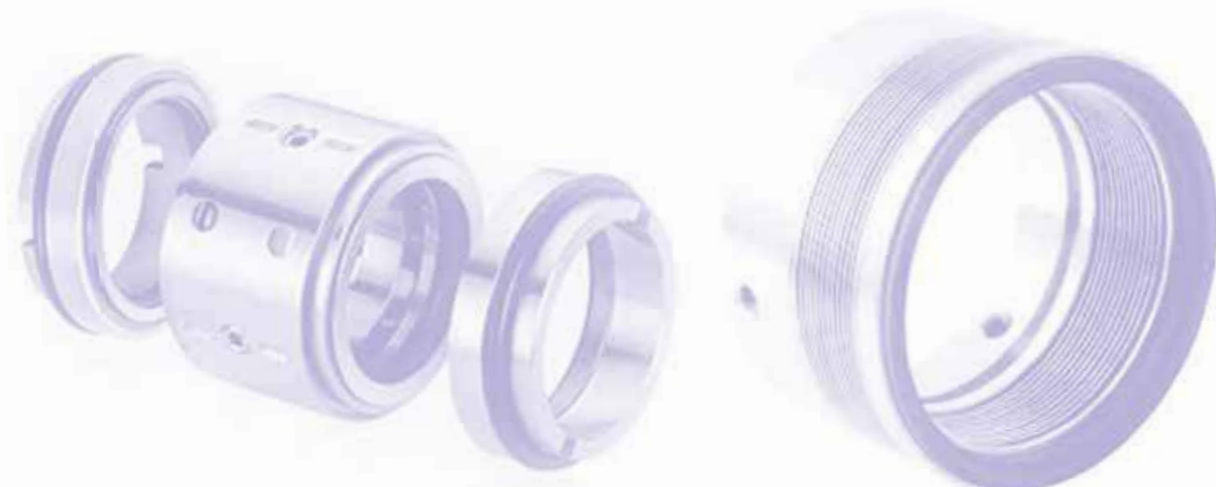

### Products / Services:



Single Spring Mechanical Seal



Bellows



Supply System

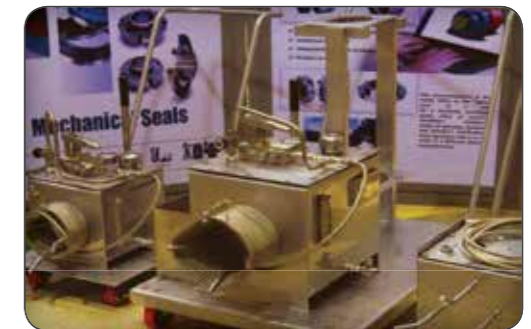

Refill Unit

Tel: +98 21 65611309 - 11  
Fax: +98 21 65611312  
E-mail: [info@arsen-co.com](mailto:info@arsen-co.com)  
Web: [www.arsen-co.com](http://www.arsen-co.com)  
Address: Iran, Tehran

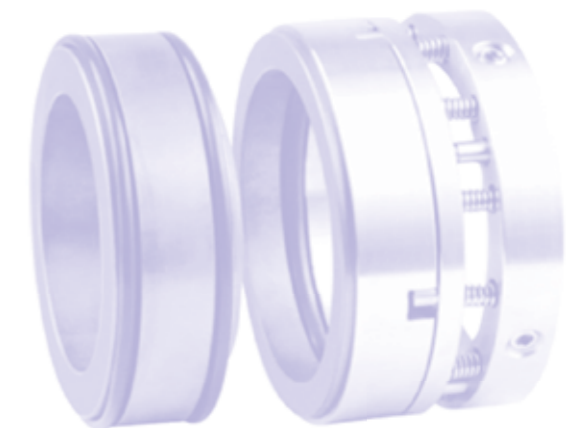

## Arvin Sanat Apadana Co.

Founded date: 2005 / 01 / 20  
Office & workshop area: 2000 m2  
Number of Staff: 12



### Products / Services:



Design and Manufacturing: -Noise Protection systems  
-Enclosure systems -Noise Barrier wall panel -Offshore Wall  
Barrier (Compressor Enclosure, Gas compressor plants)



Design and Manufacturing: -Noise Protection systems  
-Enclosure systems -Noise Barrier wall panel -Offshore  
Wall Barrier (Noise Protection Sys, Power Plants)



Design and Manufacturing: -Industrial Silencers -Fan  
Silencers -Drain Silencers -Vent Silencers -Safety  
valve Silencers (Test Bench Silencer, TUGA)



Design and Manufacturing: -Industrial Silencers -Fan  
Silencers -Drain Silencers -Vent Silencers -Safety valve  
Silencers (Drain Silencer, PARDIS petrochemical Co.)



### Products / Services:



Design and Manufacturing Refinery and Petrochemical Components:  
-Industrial Agitators -Catalyst Charging (metering) Cylinder -Flow Meter  
(Nozzle) -Spare Parts (Catalyst Meter, Lorestan Petrochemical Co.)



Design and Manufacturing Refinery and Petrochemical  
Components: -Industrial Agitators -Catalyst Charging (metering)  
Cylinder -Flow Meter (Nozzle) -Spare Parts (Agitator, Lorestan P.C.)



Manufacturing Industrial Equipment's: -Heavy industrial  
Fan -Heavy Industrial Base Frames -Conveyor systems  
-Iron Ore Separator (Fan Impeller, Isfahan Steel Co.)



Design and Manufacturing Refinery and Petrochemical Components:  
-Industrial Agitators -Catalyst Charging (metering) Cylinder -Flow  
Meter (Nozzle) -Spare Parts (Flow Meter, JAM Petrochemical Co.)



Manufacturing Industrial Equipment's: -Heavy industrial  
Fan -Heavy Industrial Base Frames -Conveyor systems  
-Iron Ore Separator (Generator Base Frame, TUGA)



Tel: +98 31 42694001 - 2  
Fax: +98 31 42694003  
E-mail: ASACo@ArvinSanat.com  
Web: www.ArvinSanat.com  
Address: No.2, 9th Alley, Aboureyhan St.  
Njafabad2 Industrial Zone, Isfahan, Iran

## ARYA SEAL PART

Founded date: 2009 / 03 / 04  
Office & workshop area: 250 & 173 m2  
Number of Staff: 25

**Arya Seal**<sup>®</sup>  
PetroSealing

### Products / Services:



DESIGN & RETROFIT



DGS SEAL



DOUBLE AGITATOR SEAL

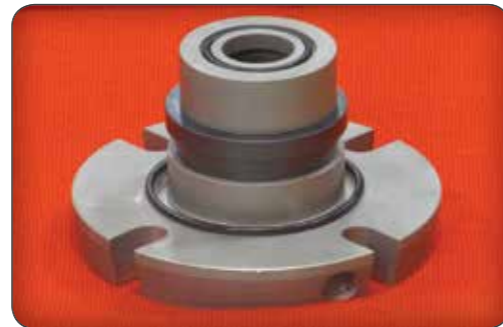

DOUBLE CARTEX SEAL



DOUBLE CARTRIDGE SEAL



JOURNAL BEARING (SiC) FOR MAGNETIC PUMP

### Products / Services:



M3N



M7N



MG1



METAL SPARE PARTS



PTFE BELLOWS



SUPPLY SYSTEM

**Arya Seal**<sup>®</sup>  
PetroSealing

Tel: +98 615 2110888 Fax: +98 615 2110889  
Telfax: +98 813 8223327 Mobile: 09125717732  
Tel: +34 962851628 Fax: +34 962851922  
E-mail: aryaseal110888@gmail.com  
E-mail: petrosealing@petrosealing.eu  
Web: www.aryaseal.ir  
Address: South Service Center: No. Talash  
complex, 1 site No, Special Economic  
Petrochemical Zone, Bander\_e Emam, Iran.  
West Service Center Address: Unit 1, Arya  
Seal Complex, No. 54, Parastoo Street,  
Motakhasasin, Hamedan, Iran  
Europe Office: Calle San Vicente  
Martir 85-7Q,E-46007 Valencia-Spain-EU

## Asto Machine and Industrial Structure Manufacturing Co.

Founded date: 2004 / 04 / 18  
Office & workshop area: 740,000 m<sup>2</sup>  
Number of Staff: 600



### Products / Services:



Ehya Steel Structure



Chador Malu steel project, Ardakan



Construction of steel structure, Royal Building project



Mirdamad Steel Structure



Darya Steel Structure

### Products / Services:



Hamila Project



Tandis Zanbagh Steel Structure



Service



H Beam



Shotblast

### Tehran Office:

Tel: +98 21 43621221 - 2

Fax: +98 21 43621220

E-mail: [info@asto.ir](mailto:info@asto.ir)

Web: [www.asto.ir](http://www.asto.ir)

Address: Unit 202 & 203, No 2 , 3rd

12-meter dead end , Golestan street ,Agha

Ali khani street, South shiraz street, Hemat

high way, Tehran-Iran

Postal Code: 1436935791

### Factory:

Tel: +98 28 32939030 - 5

Fax: +98 28 32939032

Address: 15 km after Abyer Cement,

Karaj-Qzvin Highway Pay Toll, (North of

Gas Station), Abyek, Iran

Postal Code: 3444151363

## AZARAB INDUSTRIES Co.

Founded date: 1988  
Office & workshop area: Central Office 4,020 m2 in Tehran  
& Work Shop 330,000 m2 in Arak and Assaluyeh  
Number of Staff: 1764



### Products / Services:



Heat Recovery Steam Generator(HRSG/ WHB)  
Montzer Ghaem Power plant



Water Tube Boiler  
Shahid Rajaie Power plant



Columns  
Shazand Arak Refinery



Tanks / Vessels & Drums  
Ilam Refinery



Reactors/ Heater/Reformer  
Amir Kabir Petrochemical



Exchangers /Air Coolers  
Abadan Refinery

### Products / Services:



Mining Equipment(Cement Plant)  
Shahrekord Cement Plant



Hydraulic Power Plant and Equipment Turbine  
Karoun 3 Dam



Water Treatment (Ro, Thermal Desalination, ...)  
Esfahan Refinery



Air Separation Unit  
Bandar Abbas Gas Condensate Refinery



Flare  
Bid Boland Refinery



Tel: Arak: +98 86 33136200 - 9 Tehran: +98 21 88799443  
Fax: Arak: +98 86 33134382 Tehran: +98 21 88799443  
E-mail: [Marketing@Azarab.ir](mailto:Marketing@Azarab.ir)  
Web: [www.Azarab.ir](http://www.Azarab.ir)  
Address:  
Work Shop: Sanat Square - Arak  
Central Office: No.15 - MollaSadra St- Vanak Square - Tehran

## Behesht Kavir Ariana

Founded date: 2008 / 09 / 07  
Office & workshop area: 21,000 m2  
Number of Staff: 38



**BKA Industrial Group**  
Pipe, Fitting & Storage tank  
FRP, GRE, GRP, GRV

### Products / Services:



BKA's Company (GRE,GRP,GRV pipe)



BKA's Lab.



Engineering & Oil development Co. (GRP pipe)

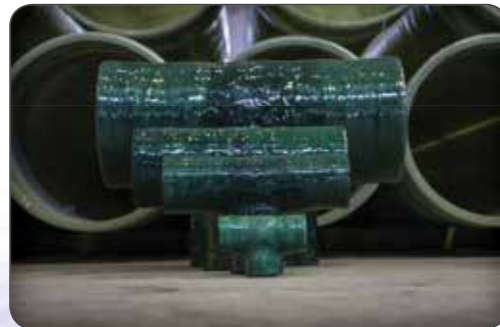

Fajr Petrochemical, Mahshahr (fitting)

### Products / Services:



Mobin Petroleum (GRP pipe)



PKSK Co. (GRE pipe)



Sout Gas Pars Complex (GRV Flange)



Tana energy management Co. (GRVE Flange)



Tehran Refinery (GRV Flange)

Tel: +98 28-32848772 - 5  
Fax: +98 28-32848772  
E-mail: sales@bkagr.com  
Web: www.bkagr.com  
Address: Sanat 6 St, Sanat square, Caspian Industrial town,  
Qazvin, Iran



Shaya energy management Co.  
(BKA)



## Centigrade Ind. Inc.

Founded date: 1981  
Office & workshop area: 10,000 m2  
Number of Staff: 100



### Products / Services:



Air conditioning and filtration for Textile Ind.



Air conditioning & air movement for metro



Tunnel ventilation, firefighting and automation



Damper valve, Louvers and silencer

### Products / Services:



Turbine air intake cooling



Precipitator and dust filtration



Air distribution package for air cooler



FOG system cooling

Tel: +98 713 774 2793 - 5  
Fax: +98 713 774 2796  
E-mail: Info@Ciinc.Co  
Address: St. No. 403, Bahrevari Ave., Electronic Sqr.,  
Shiraz Industrial Estate, Shiraz – Iran

## Chamaan Engineering and Fabrication

Founded date: 1994 / 03 / 30  
Office & workshop area: 300 & 10,000 m2  
Number of Staff: 55



### Products / Services:



Direct fired heater

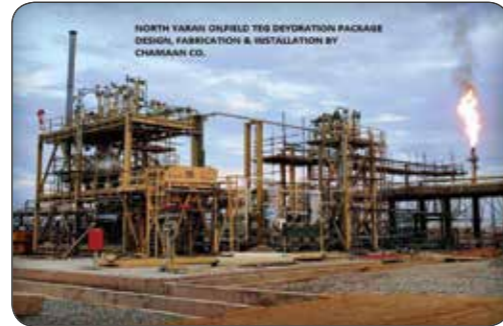

TEG Dehydration Package



Oily Water Treatment Package



Chemical Injection Package

### Products / Services:



Regeneration Loop Gas Dryer



Spent Caustic Treatment Package Persian Gulf Star Refinery Client: Namvaran p&t (nardis-pgsoc)



Reformer Marjan methanol plant



Nitrogen storage package Khesht oil field



Chemical injection package Khesht oil field



Tel: +98 21 22212994  
Fax: +98 21 22231608  
E-mail: nar@chamaan.com  
Web: www.chamaan.com  
Address: Floor 5, No. 4, Edge of Sadr Highway, End of Delpazir Alley,  
Roshanaei St. Qeytarieh,  
Tehran, Iran

## Daboo Sanat Co.

Founded date: 1994  
Office & workshop area: 24,000 m2  
Number of Staff: 250



### Products / Services:



Bandar Bushehr Staff Cooperative Co.  
Iran – Bushehr  
Thermal Water Desalination



Bandar Bushehr Staff Cooperative Co.  
Iran – Bushehr  
CHP – Waste Gas Boiler



Foolad Mobarakeh Co.  
Iran – Isfahan  
Box Annealing Furnaces



Chuka Co.  
Iran – Gilan  
30,000 kg/hr Steam Boiler



Atrin Parseh Greenhouse  
Uzbekistan  
Hot Water Boilers 4.500.000 K/Cal



Azar Shamas Spaghetti  
Afghanistan – Mazar Sharif  
Automatic Coal Burner

### Products / Services:



Rozgar  
Iraq – Erbil  
Hot Oil Heater



Hexane Polymer Petrochemical Co.  
Iran - Khozestan  
30,000 kg/hr Steam Boiler



Foolad Mobarakeh Co.  
Iran – Isfahan  
Iner Cover



Electricity Neka  
Iran – Mazandaran  
Heat Exchanger Shell & Tube



Foolad Mobarakeh Co.  
Iran – Isfahan  
Air Cooler



Makhzan Foolad Rafe Co. Iran – Mazandaran  
Normalizing, Annealing and Stress Relief Furnace  
Capacity 450 M3

Tel: +98 11 4436  
Fax: +98 11 4436  
E-mail: [info@daboosanat.com](mailto:info@daboosanat.com)  
Web: [www.daboosanat.com](http://www.daboosanat.com)  
First phase Address:  
laleh St, Shohada (tashbandan) Ind. Zone,  
Mahmood Abad- Mazandaran- IRAN

## Damafin Thermal Technology Co.

Founded date: 1994 / 03 / 10  
Office & workshop area: 16,500 m<sup>2</sup>  
Number of Staff: 200



### Products / Services:



Yadavaran Oil Field



Spare Parts for Air Cooled Heat Exchanger

### Products / Services:



Finned Tube



Shell & Tube Heat Exchanger

Tel: +98 21 44922694  
Fax: +98 21 44922494  
E-mail: [sales@damafin.com](mailto:sales@damafin.com)  
Web: [www.damafin.com](http://www.damafin.com)  
Address: Damafin Co., Zamyad St., Irankhodor Blvd., 14 th km of Karaj Rd.,  
Tehran, Iran

## Deylaman Filter

Founded date: 1996 / 06 / 12  
Office & workshop area: 4,942 m<sup>2</sup>  
Number of Staff: 31



### Products / Services:



Design and Manufacture of filter systems



### Products / Services:



Design and Manufacture of industrial filters  
(Gas Filter-Liquid Filter-Air filter-Strainer Filter) used in  
oil, gas, refinery, petrochemical and power plant industries



Design and Manufacture of Separator, Scrubber and  
Knock out Drum Internals

Tel: +98 21 88715528 - 9  
Fax: +98 21 88705510  
E-mail: [info@deylamanfilter.com](mailto:info@deylamanfilter.com)  
Web: [www.deylamanfilter.com](http://www.deylamanfilter.com)  
Address: No20, Azadegan Alley, Ghaemmagham Farahani St, Tehran, Iran

## Ebdaagaran Padide Knowledge - based company

Founded date: 1998 / 08 / 19  
Office & workshop area: 2,400 m2  
Number of Staff: 27



### Products / Services:

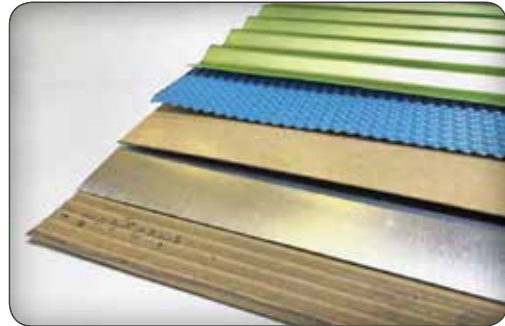

Manufacturer of Aluminium jacketing Insulation with Polysurlyn moisture barrier, super Polykraft moisture barrier and Polykraft moisture barrier with continuous casting method



Manufacturer of different types of Polysurlyn and Polyethylene films

### Products / Services:



Manufacturer of Seamless alloy steel tubes



Manufacturer and supplier of all metallic and non-metallic accessories.

Tel: +98 21 22973890  
Fax: +98 21 22974368  
E-mail: [Info@egpco.com](mailto:Info@egpco.com)  
Web: [www.egpco.com](http://www.egpco.com)  
Address: 2nd Floor No. 40 Ghiasi St. Zabeti St. Ghazi Zahedi St.  
Panahinia Blvd. Heravi Sq. Tehran, 1667846111 Iran

## Esfahan Machinery Manufacturing Company

Founded date: 1986  
Office area: 1,500 m<sup>2</sup> Workshop area: 150,000 m<sup>2</sup>  
Number of Staff: 370



### Products / Services:



Storage Tank  
Marjan Petrochemical Co.



Pressure Vessel  
Kordestan Petrochemical Co.



Silo / Duct  
Apadana Ceram Co.



Heat Exchanger  
Fiber Intermediate Products Co. (DMT)

### Products / Services:



Material Handling System  
GISD Mega Module Kowsar- Sirjan



Dedusting System  
Mobarakeh Steel Co. (Kharazi Project)



Special Equipment such as Stacker-Reclaimer  
Esfahan Steel Co.



Steel Structures  
Vian Steel Co.



Mechanical construction contractor for oil, gas, petrochemical, steel, aluminum, copper, cement, power plants and other chemical, mineral, and food industries.  
Reference: Methanol Plant, Marjan Petrochemical Co. Assaluyeh

Tel: +98 21 88778912  
Fax: +98 21 88778925  
E-mail: [info@emmc.ir](mailto:info@emmc.ir)  
Web: [www.emmc.ir](http://www.emmc.ir)  
Address: No. 48, Alvand St., Argentina Sq., Tehran, Iran  
Postal Code: 1516644418

## Euroslot Pars

Founded date: 2003 / 01 / 08  
Office & workshop area: Office:650 m2 Factory:7640 m2  
Number of Staff: 156

### Products / Services:



1- All types of Reactor Internals  
(CCR reactor of Persian Gulf Star Refinery)



2- Vessels/Driers Internals  
(Internals for Drums of Isfahan Oil Refinery)



3- All types of Column Internals  
(Tower internals of Bushehr petrochemical Co.)



4- Silencers  
(Siraf Petrochemical Co.)



5- Two phase separators  
(Mist eliminator for Aria Sasol Polymer Co.)



6- Three phase separators  
(Axial cyclone for Aria Sasol polymer Co.)



### Products / Services:



7- All types of strainers  
(Strainers for south pars gas field - phase 22,23&24)



8- Internals for sand filters  
(sand filters of Dena & Sabalan petrochemical Co.)



9- Static Mixers  
(Mixers of Bandar Abbas Oil Refinery Co.)



10- All types of cartridge filters up to 2 micron  
(Filters of Jam Petrochemical Co.)



11- All types of Oil & Gas Well screens  
(Prepack screen for I.O.O.C)

Tel: +98 21 88686942 - 3  
Fax: +98 21 88686168  
E-mail: info@euroslotpars.com  
Web: www.euroslotpars.com  
Address: No. 2, Unit 2, East 32nd.St.,  
(East Qeysari) South Allameh Ave.,  
Sa'adatabad Area, Tehran



12- Internals for Special Vessels  
(Ammonia synthesis converter of Pardis petrochemical plant)





## Fakoor Meghnatis Spadana Co.

Founded date: 1992  
Office & workshop area: 700 m2  
Number of Staff: 118



### Products / Services:



Belt Conveyor



Wet Magnetic Drum Separator

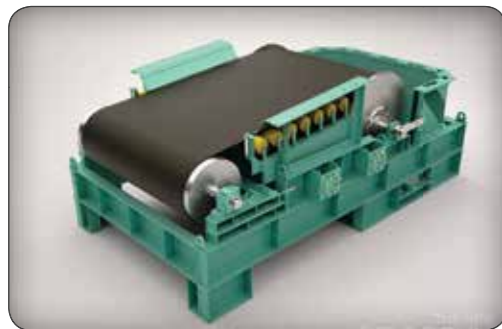

Belt Magnetic Drum Separator



Gol Gohar – Flotation



Sangan-Flotation



ROLLER SCREEN

### Products / Services:



ROLLER SCREEN



Unit Mobail



semi-mobile



SCREEN



Feeder

Tel: +98 21 88544643  
Fax: +98 21 88742203  
E-mail: [info@fms-co.com](mailto:info@fms-co.com)  
Web: [www.fms-co.com](http://www.fms-co.com)  
Address: No. 20, Sarafraz St., Shahid  
Beheshti Ave., Tehran – IRAN



Crusher

## FARAB

Founded date: 1986 / 05 / 01  
Office & workshop area: 10,000 m2  
Number of Staff: 200



### Products / Services:



Butterfly valve wafer type



Butterfly valve Flange type



Bellows globe valve



Globe valve



Gate valve



Check valve

### Products / Services:



Strainer



Manual Balancing Valve



PIBCV- Pressure Independent Balancing Control Valve



Fan Coil Balancing Unit



Chitgar Construction Company



Mammut Company

Tel: +98 21 89630  
Fax: +98 21 88660423  
E-mail: info@farabvalve.com  
Web: www.farabvalve.com  
Address: No.13, 29 Zagross Street,  
Argentina Square.

## Faradid Meehan Engineering Company

Founded date: 1994 / 11 / 24  
Office & workshop area: 370 + 7,000 m<sup>2</sup>  
Number of Staff: 120



### Products / Services:



Designing-prepared Construction of hydromechanical equipment Hydromechanical and electrical equipment of Ajabshir



Hydromechanical and electrical equipment of Gotvand Dam



Hydromechanical and electrical equipment of Khoda afarin Dam

### Products / Services:



Hydromechanical and electrical equipment of Abas abad Dam



Golab



Hydromechanical and electrical equipment of Siyazakh Dam

Tel: +98 21 66975380 - 81 - 85  
Fax: +98 21 66975198  
E-mail: [info@faradidmeehan.com](mailto:info@faradidmeehan.com)  
Web: [www.faradidmeehan.com](http://www.faradidmeehan.com)  
Address: Unit 14 No 101 Baradaran Mozafar St. Enghelab Av.

## Farapishtaz Hoonam Rubber Industries

Founded date: 2014 / 12 / 28  
Office & workshop area: 36,000 m2  
Number of Staff: 65



### Products / Services:



Packing

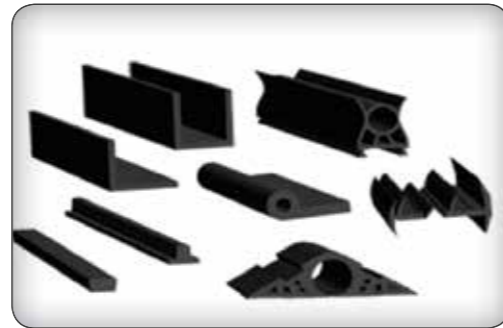

Rubber profiles



Gasket



O-Ring



### Products / Services:



Bladder Rubber



diaphragm



Rubber- metal combined parts

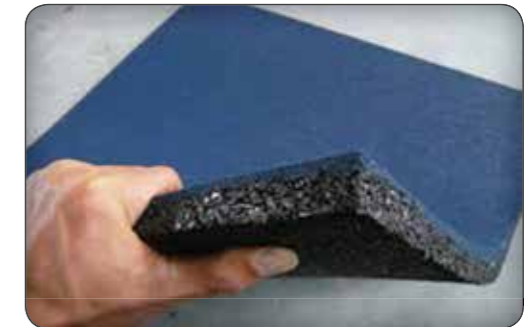

Rubber Flooring



Tel: +98 36750201  
Fax: +98 36750201  
E-mail: [info@farapishtaz.com](mailto:info@farapishtaz.com)  
Web: [www.farapishtaz.com](http://www.farapishtaz.com)  
Address: No.249, 22. Ave , Eram Blvd, Shiraz, Iran

## Farayand Bokhar

Founded date: 2003 / 11 / 25  
Office & workshop area: 4,500 m2  
Number of Staff: 80 To 150 manpower



### Products / Services:



Water Tube Steam Boilers



Fired Heaters



HRSG



Hydrogen Annealing Furnaces



Waste Heat Boilers



Loading Arms

### Products / Services:



SRJ



Silencers



Pressure Vessels



Deaerators



Ejector Packages



Desalters

Tel: +98 21 88690307 - 8 +98 21 88690607 - 9  
Fax: +98 21 88690607 - 9  
E-mail: [info@farayandbokhar.com](mailto:info@farayandbokhar.com)  
Web: [www.farayandbokhar.com](http://www.farayandbokhar.com)  
Address: Unit 14, No 36, Next to 21st Ave (Kanani Moghadam), Saadatabad, Tehran, Iran

## Farineh Machine

Founded date: 2008  
Office area: 1,150 m<sup>2</sup>  
Workshop Area : 5,550 m<sup>2</sup>  
Number of Staff: 100



### Products / Services:



25 Kg Bagging Machine



Bucket Elevators



Pocket Conveyors



Wagon Loading Stations



### Products / Services:



Hoppers



Reclaimer



Palletizing and Shrink-Wrapping Machines



Big Bag Filling Machine

Tel: +98 21 44024051 – 55  
Fax: +98 21 44969846  
E-mail: [info@farinehmachine.com](mailto:info@farinehmachine.com)  
Web: [www.farinehmachine.com](http://www.farinehmachine.com)  
Address: #11, Paezan St., Kashefi Nik St., Bahonar St., Ashrafi Esfehni highway,  
Tehran, Iran.

## Fars Afzar Kimiya Co.

Founded date: 1996 / 10 / 04  
Office & workshop area: 7,000 m<sup>2</sup>  
Number of Staff: 272



### Products / Services:



Unmanned helicopter



Hydromotor



OIL PUMP (TRIPLE SCREW PUMP)



Impellers, inducer, Turbo expander parts, Turbine Parts and Blades



Pad bearing, Thrust bearing, Journal bearing, labyrinth seal



Shafts

### Products / Services:

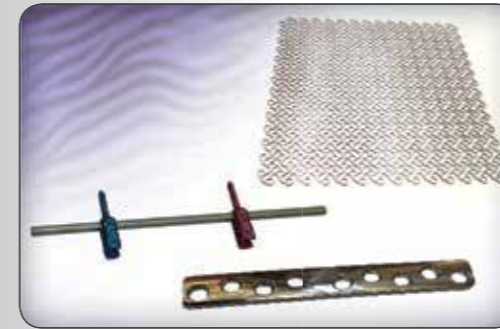

Medical parts: Nail, Plaque, Spin set, Cross-fit screw, Mesh, Burr hole, Burr Hole Covers, hole T-Plate, Chin plate, Orthopedic Implants



Different types of actuators, pumps and sensors



pumps parts, gears, Various types of PEEK, PTFE, Carbon Teflon, polyamide, plastic and ... Parts



Rolls-Royce and Solar turbines parts



Parts, Components and equipment for production lines

Tel: +98 7138241891  
Fax: +98 7138248184  
E-mail: info@afarkimiya.com  
E-mail: mr13870631@yahoo.com  
Web: www.afzarkimiya.com  
Address: Fars - Shiraz - Boulevard of Justice - K 62

## Fateh Sanat Kimia

Founded date: 2000 / 08 / 02  
Office & workshop area: 200,000 m2  
Number of Staff: 900 person in factory 5,000 person in group



### Products / Services:



Shell & Tube Exchanger  
TEMA / Non TEMA Vertical / IBW (SPGC)



Air cooled Heat Exchanger  
ASME Sec VIII Div. 2 (Serajeh Gas injection Plant)



Water Tube boiler / HRSG  
Customize design (Kharg PC.)



Plate Heat Exchanger  
Welded / Gasket sealed / Semi welded brazed / spiral (SPGC)



Pressure Vessel/ Tower/ Column  
ASME/ BS PD 5500 (Bid Boland Refinery)



Process Reactor  
(Bushehr Methanol Plant)

### Products / Services:



Waste Heat Boiler  
(Zagros Methanol Plant)



Transfer line exchanger  
(Maroon PC.)



Furnace / combustion systems / Incinerator package / reformers (Marjan Methanol Plant)



Flare and Burn pit  
(Kermnshah PC.)



Surface Condenser  
(Esfahan Oil refinery)

Tel: +98 7137742141  
Fax: +98 7137742140  
E-mail: [Info@fatehsanat.com](mailto:Info@fatehsanat.com)  
Web: [WWW.Fatehsanat.com](http://WWW.Fatehsanat.com)  
Address: Sanat Sq. Shiraz Industrial Zone  
Shiraz - Iran



Skid mounted package  
(SPGC)





## Foolad Paya Engineering Co.

Founded date: 1994 / 01 / 22

Office & workshop area:

Ahwaz's workshop: 40,000 m<sup>2</sup> Esfahan's workshop: 15,000 m<sup>2</sup>

Tehran office: 1,000 m<sup>2</sup>

Number of Staff: 383



### Products / Services:



Pressure Vessels, Tower, Columns,  
K.O. Drums, Reactor



Storage Tanks, Atmospheric Vessels



Heat recovery systems, Heat Exchangers,  
Furnaces, Tube Bundles, Air Cooler



Reformer

### Products / Services:



Flare



Industrial Steel Structure



Material Handling Systems



Construction Works

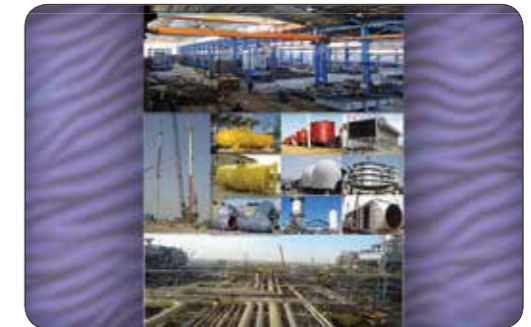

General



Tel: +98 21 88614376 - 83  
Fax: +98 21 88614385  
E-mail: [info@paya.ir](mailto:info@paya.ir)  
Web: [www.paya.ir](http://www.paya.ir)  
Address: 142, Vanak St. North Shiraz St.  
Tehran, Iran.

## **GARMA GOSTAR (ENERGY ENGINEERING)**

**Founded date: 1980 / 11 / 03**

**Office & workshop area: 3,400 m2 & 30,000 m2**

**Number of Staff: 250**

Production of Technical Knowledge, Design, Construction, Supply of Materials,  
Installation and Commissioning Of Industrial Equipment



### Products / Services:



Steam Water Tube Boilers:  
Up to 600 Tons per Hour under License of Eck Rohr  
Kessel GMBH Germany



Fire Tube Boilers:  
Up to 50 Tons per Hour



Hot Water Fire Tube Boiler:  
Up To 110 Million BTU / Hour



Pressure Vessels: Vertical and Horizontal Design With  
All Attachments, Including Internals, Ladder, Platform,  
External Jacket, Internal Coil



Distillation Towers: Packed Column Type & Tray Type  
with Simulation, Hydraulic Mechanical Calculation  
with All of Internal & External Attachments

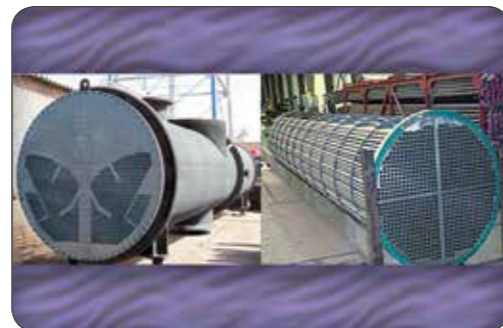

Shell & Tube Heat Exchangers:  
With process, heat transfer & mechanical calculation  
with all attachments

### Products / Services:



Double Pipe Heat Exchanger:  
ASME & TEMA



Economizers:  
Design & construction Up To 600 Tons per Hour



Super Heaters:  
ASME Sec1 up to 530 °C



Chemical Reactors:  
With Agitators, Internal Coil & External Jacket and All  
Attachments



Separators: Vertical and Horizontal Design With  
Attachments, Including Internals, Ladder, Platform,  
External Jacket, Internal

**Tel: +98 21 88767222**  
**Fax: +98 21 88762805**  
**E-mail: info@garmagostar.com**  
**Web: www.gannagostar.com**  
**Address:**  
**Office: No. 95, D1: Beheshti Ave. Tehran,**  
**Iran, postal code: 1559617113**  
**Factory: No. 22, Mofatteh Alley,**  
**22 Bahman ST., Shahid Madani Avenue,**  
**km 20 of the old road of Tehran / Qom,**  
**Tehran, Iran**



Deaerators And Water Softeners: Vertical And Horizontal  
Design With All Attachments, Including Internals,  
Ladder, Platform, External Jacket, Internal Coil

## HAVA FILTER Industrial Air Pollution Control Systems

Founded date: 1991 / 11 / 11  
Office & workshop area: 3,000 m<sup>2</sup>  
Number of Staff: 40



### Products / Services:



VENTURI TYPE SCRUBBERS  
Chadormalu Direct Reduction & Steel Making Plant  
Sangan Pelletizing Plant 1&2. Pasargad Steel Making Plant



BAG FILTERS (Jet - Pulse)  
Chadormalu Direct Reduction & Steel Making Plant  
Sangan Pelletizing Plant 1&2. Abade, Jovein, Delijan Cement Co.



FANS (3000m<sup>3</sup>/h to 200000m<sup>3</sup>/h)  
All of Mentioned Projects



Bag Houses (Pulse & Reverse Air)  
Ardakan Pelletizing Plant  
Jovein, Abadeh, Delijan Cement Co.,  
SUNGUN Copper Mine Industry



### Products / Services:



Packed Towers  
Ettehad Lent Pishro Sanat Co.



Rotary valves  
All of Mentioned Projects



Screw Conveyors  
All of Mentioned Projects

Tel: +98 21 88701442 - 4 +98 21 88712162  
Fax: +98 21 88720650  
Mob: +98 912 1185682  
E-mail: hava\_filter@yahoo.com  
Web: www.hava-filter.com  
Address: No 205, Between Ave. 19&21, Asadabadi St. Tehran. Iran  
Post: 1433913345

## Heavy Duty Pumps and Water Turbine M.F.G. Co.

Founded date: 1992 / 03 / 28  
Office & workshop area:  
Office: 500 m<sup>2</sup> , Workshop: 80,000 m<sup>2</sup>  
Number of Staff: 200



### Products / Services:



SHAZAND Refinery  
Pump Model: CP-200.565  
Capacity: 320 m<sup>3</sup>/h, Head :88m , Power :90 kw



PERSIAN GULF STAR Refinery:  
Pump Model : VSP1-1200.1300  
Capacity: 12200 m<sup>3</sup>/h, Head: 54 m, Power: 2.5 MW



ESFAHAN Refinery  
Pump Model: VDL6-40.250  
Capacity: 14 m<sup>3</sup>/h, Head: 127 m, Power: 30 KW



LAVAN Refinery  
Pump Type: BB5  
Capacity: 25 m<sup>3</sup>/h, Head: 369.8 m, Power: 30kw



PIPE LINE & OIL Telecommunication  
Pump Model :HG2-150.400  
Capacity: 300 m<sup>3</sup>/h, Head: 120 m, Power: 200 kw



GHESHM Sea Water Intake  
Pump Type: VS1  
Capacity: 2200 m<sup>3</sup>/h, Head: 70 m, Power: 630 kw

### Products / Services:



NISOC Project  
Pump Model: BS3-6x6  
Capacity: 100 m<sup>3</sup>/h, Head: 370 m, Power: 200kw



ENTEKHAB Petrochemical Project  
Pump Model: CP-80.315  
Capacity: 132 m<sup>3</sup>/h, Head: 139 m, Power: 90 Kw



MARUN Petrochemical Project, Cooling Water Pumps  
Pump Type : BS1-600.800  
Capacity: 5000 m<sup>3</sup>/h, Head : 71 m, Power: 1.3 MW



MAPNA Project, Cooling Power Plant  
MAPNA TURBINES, Type: KAPLAN  
Capacity: 13700 m<sup>3</sup>/h, Power: 500 KW



MAPNA Project, Cooling Power Plant  
Pump Type : 1200 DD 135  
Capacity: 13700 m<sup>3</sup>/h, Head: 36 m, Power: 1.2 MW

Tel: +98 21 26701548 - 78  
Fax: +98 21 22840681  
E-mail: Sale@pumpturbine.ir  
Web: www.pumpturbine.ir  
Address: No.2, KAZEMI MOGHADAM St.,  
FAROKHI YAZDI Sq., 8th NEGARESTAN St.,  
PASDARAN Ave.,  
TEHRAN, IRAN



ILAM Petrochemical Project  
Pump Model: VENUS 1-500.800  
Capacity: 4200 m<sup>3</sup>/h, Head: 50m, Power: 850 kw

## Industrial Pioneers Farayand

Founded date: 1999 / 07 / 06  
Office & workshop area: 16,600 m2  
Number of Staff: 90



### Products / Services:



Water Treatment plant (Zero Liquid Discharge)



Manufacturing Salt Purification Plants



AAC Production Plant (EPC)



Design and Establish of API Plants

### Products / Services:



Design, Manufacturing and installation of Chemical Injection Packages



Design and Manufacturing of Equipment such as Pressure Vessels, Storage Tanks, Centrifuge, Dryers, Mixers, Thickener, Crystallizer, Evaporator



Design and Installation of Clean Room

Tel: +98 21 6374  
Fax: +98 21 66423489  
E-mail: [info@ipfarayand.com](mailto:info@ipfarayand.com)  
Web: [www.ipfarayand.com](http://www.ipfarayand.com)  
Address: Unit7, No.10, 1St KosarSt, Tohid Sq.

## INTERLOCK Co. Industrial Turn-key Groups

Founded date: 1973 / 02/ 22  
Office & workshop area: 3,810 m2  
Number of Staff: 60



### Products / Services:



Spiral Pipe Plant SPPC-2018



Pipe Internal FBE Coating SPPC-2016



Bitumen Plant Soleymaniye-2012



Bumper Painting Plant SAIPA-2008



Bumper Painting Plant MCP-2001

### Products / Services:



Cement Lining Plant Tehran-1995



Crystal Melamine Plant Uromieh-1993



Sulfur Recovery Plant Arak-1992



External Pipe Coating Plant Tehran-1984



Gas Storage Plant Tehran-1984



Tel: +98 21 44905590 - 1  
Fax: +98 21 44905590 - 1  
E-mail: [Info@interlock.ir](mailto:Info@interlock.ir)  
Web: [www.interlock.ir](http://www.interlock.ir)

Address:  
Main Office: Unit3, No.3, Maryam St, Hosseini St, Sohrevardi St, Tehran  
Factory: No.4, south Jahad St, Km 11 Lashkari High Way, Tehran

## Jahan Ayegh Pars

Founded date: 2005 / 06 / 21  
Office & workshop area: 62,000 m2  
Number of Staff: 225



### Products / Services:



Aluminum Jacketing & Accessories



Ceramic Fiber



Foam Glass



Polyurethane & Polyisocyanurate



### Products / Services:



Removable Jacketing & Pillow Insulation



Rock Wool



Rock Wool-2

Tel: +98 3142990  
Fax: +98 2142693400  
E-mail: [info@jahanayegh.com](mailto:info@jahanayegh.com)  
Web: [www.jahanayegh.com](http://www.jahanayegh.com)  
Address: No. 12, 101 Ave, Montazerieh Industrial Zone, Najafabad,  
Isfahan, Iran

## Jahankar Esfahan

Founded date: 1986  
Office & workshop area: 43,275 m<sup>2</sup>  
Number of Staff: 175



### Products / Services:



Steel structure for industrial&building

Watertube & firetube boiler

Storage & vessels tank

Water & gas pipe ,piping,welding pipe,  
manufacturing the gas & water pipes up to 6inch diameter. API5L Gr.B.



Tel: +98 3136631283

Fax: +98 3136617182

E-mail: [Info@jahankarco.com](mailto:Info@jahankarco.com)

Web: [www.jahankarco.com](http://www.jahankarco.com)

Address: First east floor, NO.1 -Noraieian Alley-saadat abad st- Esfahan - IRAN



## Kaveh Mobadel

Founded date: 2000 / 03 / 07  
Office & workshop area: 2,500 m<sup>2</sup>  
Number of Staff: 250



### Products / Services:



Air Cooler



Atmospheric Storage Tank



Column



Gas Filter

### Products / Services:



PRESURE VESSLE



Seperator



Shell & Tube1



Shell & Tube



Shell & Tube

Tel: +98 21 44981021  
Fax: +98 21 44985932  
E-mail: SALES@KAVEHMOBADEL.COM  
Web: WWW.KAVEHMOBADEL.COM  
Address: NO 216, 19th km, Special Karaj Road Tehran, Iran  
Zip: 1389133751

## Kavosh Sanat Toos

Founded date: 2003 / 11 / 12  
Office & workshop area: 3000 m2  
Number of Staff: 150



### Products / Services:



High Speed Centrifugal Pump, single stage  
(OH6 Type)



High Speed Centrifugal Compressor, Single stage  
(OH6 type)

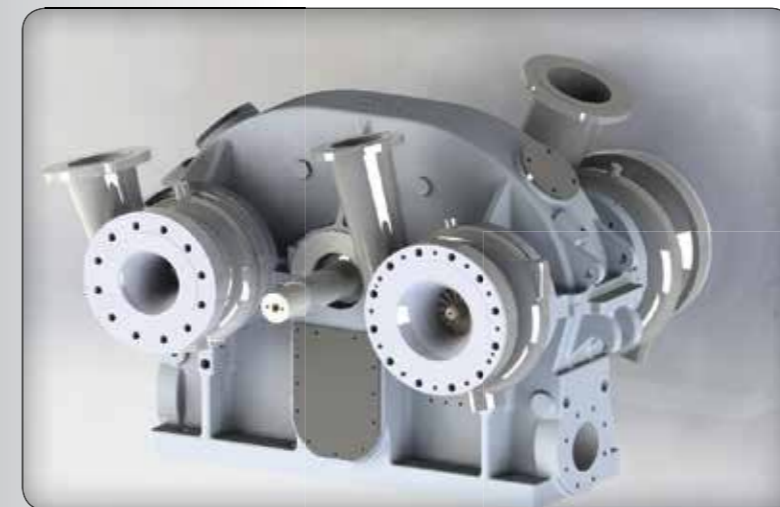

High Speed Centrifugal Compressor, Multi stages



Tel: +98 51 35421701 - 5  
Fax: +98 51 35421706  
E-mail: info@kstc.ir  
Web: www.kstc.ir  
Address: Khorasan science and technology park,  
Mashhad, Iran

## KIMIAGARAN SANAT PARS Co.

Founded date: 2007 / 07 / 16  
Office & workshop area: 1,500 m<sup>2</sup>  
Number of Staff: 15



### Products / Services:



Flare system  
(Flare system of Kavian Petrochemical plants)

### Products / Services:



Burn Pit systems  
(Burn Pit system of Phase#1 of POGC)



Fired Heaters  
(Manufacturing of Fired heaters for Bushehr Petrochemical Company)

Tel: +98 7132275200 +98 7132295846  
Fax: +98 7132275201  
E-mail: [INFO@KSP-CO.COM](mailto:INFO@KSP-CO.COM)  
Web: [WWW.KSP-CO.COM](http://WWW.KSP-CO.COM)  
Address: No.2, 2nd Lane, Daneshjoo Blvd, Shiraz,  
7143613555, Iran

## Klevers Aryana

First design, manufacturing, installation of jacket insulation and high quality of textile expansion joints.

Founded date: 2004 / 03 / 16  
Office & workshop area: 2,500 m2  
Number of Staff: 68



### Products / Services:

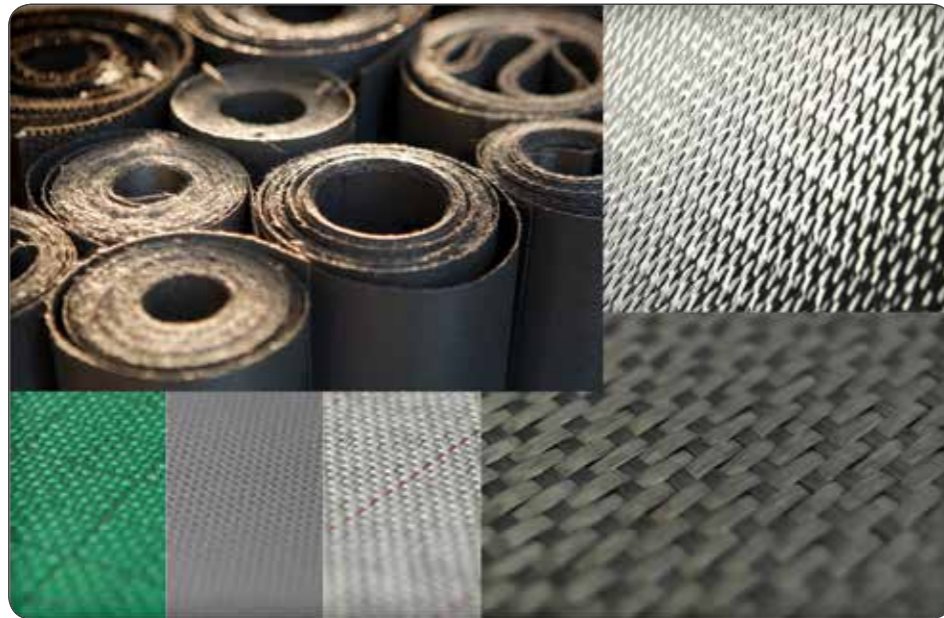

Versatile insulation material for all temperature range from -168 °C to +1260 °C  
Good chemical resistance at high temperature.

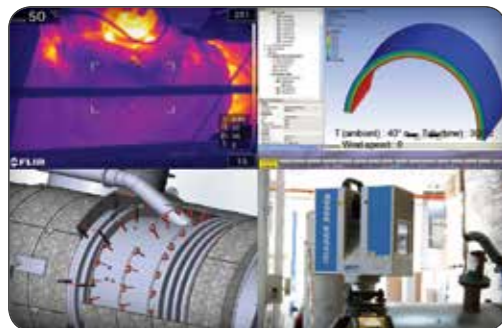

- Design and engineering
- CAD-CAM modeling
- Thermal analysis
- CNC cutting
- Optimized manufacturing conditions.



- Insulation of gas turbines
- Thermal, acoustical jacket

### Products / Services:



Cladding insulation for gas, steam turbines ancillary systems.



-Re-design and modernized old insulation system, to high quality insulation jackets. -Increasing the efficiency, decreasing the heat loss, easy handling.



Passive fire protection jackets to protect assets, ESDV valves, in challenging environment. Certified in accordance to UL1709.



Thermal and acoustical insulation for valves, flanges and equipment.



Expansion joints, klevers expansion joints, spring joints are manufactured based on U-type, belt type method to offer the best result.



Corrosion repair and protection system  
Solution to corrosion chemical attack, abrasion and wear problems by design and applying of repair composite materials and protection coating.

Tel: +98 21 88209706 - 7  
Fax: +98 21 88209708  
E-mail: [info@klevers-aryana.com](mailto:info@klevers-aryana.com)  
Web: [www.klevers-aryana.com](http://www.klevers-aryana.com)  
Address:  
Head office: ground Flr, Baharan building,  
NO.21, Corner of 27th (Rashel kuri) vozara,  
Argentina Sq., Teran, Iran.  
Factory: NO. 40, Nastaran 14, phase 2,  
Industrial city Hashtgerd.

## MACHINE ROLL Co.

(Design and manufacturing of mining and construction machinery)

Founded date: 1969

Office & workshop area: Office building: 400 m<sup>2</sup> Factory: 24,000 m<sup>2</sup>

Number of Staff: 48

Description: Impact crushers - jaw crushers - screw washing machine - screens - vertical shaft impact crushers (rock on rock) - feeders - conveyor belts - scrubber - cone crushers - bachin plants - asphalt plants.



Products / Services:



Jaw crushers  
All type of jaw crushers (90x30 - 75x45 - 80x55 - 90x40 - 100x80 - 100x63 - 110x90)



Vertical shaft impact crushers  
(rock on rock)  
The last technology of Europe for sand making



Two shafts Screens  
In variety types and dimensions



Asphalt plant  
All type of asphalt plant  
(80 t/h - 100 t/h - 120 t/h - 160 t/h)



Impact crushers  
hazemag types in different size and the same standard as europe



Impact crushers  
Bohringer types in different size and the same standard as europe

Products / Services:



Heavy duty vibrating Feeders  
Heavy duty feeder type In different size



Incline Screens & bohringer type  
Full automatic screens In variety types and dimensions



Customer  
Nokan Co. In Sulaimaniyah, Iraq  
Installations and materials manufacturing machinery



Customer  
Kosar jahan Co. in Chababar  
Installations and materials manufacturing machinery



Customer  
Mashhad municipality  
Installations and materials manufacturing machinery



Customer  
Chowlab Co. in Parandak Industrial Town  
Installations and materials manufacturing machinery



Tel: +98 21 66813127 - 66813128 -  
66791997 - 66791998 - 66806068 - 66803251  
Fax: +98 21 66808832  
E-mail: MACHINEROLL@YAHOO.COM  
Web: WWW.MACHINEROLL.NET  
Address: 4th km., 15th fath, fath freeway  
(old karaj road) no. 357 Tehran - Iran  
Post code: 1387659811

## Machine Ajza Co.

Founded date: 1985  
Office & workshop area: 70,000 m2  
Number of Staff: 40 fixed & 60 contractors



### Products / Services:



Construction of 94.2 Gas Turbine Enclosure units  
(Turbine Engineering & Manufacturing Company (TUGA))



Construction of V94.2 Gas Turbine pre-filter units  
(Turbine Engineering & Manufacturing Company (TUGA))



Construction of 160MW Gas Turbine units  
(SakhteTajhizat Sepahan Company- STS (Mapna Group))



Construction of Evaporative Cooling Systems for  
160MW Gas Turbines Inlet Air  
(Ifa Sanaat Taba Company).



Construction of Acoustic Enclosure units for Industrial  
25MW Turbo Compressor Turbines (Engineering &  
Manufacturing Company (TUGA)).



Manufacture of Galvanized Coating Lines:  
Input/Output Accumulators, Wash Basins, Dripping  
Scrubbers (Isfahan-Kashan Galvanized Steel Plant)

### Products / Services:



Production of Steel Production Lines Cable Trays and  
Ladders (Isfahan Zobahan Saba Steel Development  
Plan)



Construction of Platforms, Structures & Handrails  
(Jahan Ara Arvand Steel (AJS) Factory)



Manufacture of Cement Production Line Belt Conveyors,  
Bucket Elevators, Row Material Feeders  
(East-Azarbaijan Soufian Cement Factory)



Manufacture of Conveying Systems & Hoppers over  
1000 tons (Isfahan Zobahan Saba Steel Development  
Plan)



Under the brand CLAIER:  
Hydraulic Lifting Platforms, Aerial Working Platforms,  
Hydraulic Dock Levelers



Under the brand CLAIER:  
Truck Mounted Platforms, Airline Catering Truck  
Mounted Platforms

Site 1 address: No.170 -13thSt. -Oshtorjan Industrial zone  
-SimanSepahan Road -Zobahan Highway - Isfahan- Iran  
Tel: +98 3137608131 - 3  
Telefax: +98 3137608133  
Site 2 address: No. 226 -Oshtorjan Industrial zone –  
SimanSepahan Road - Zobahan Highway - Isfahan- Iran  
Tel: +98 31 37608901 - 9  
Postal code : 8465197151  
E-mail :Info@machine-ajza.com  
Web:www.machine-ajza.com  
Web:www.claierlift.com

## Machine Rood Pars Arak

Founded date: 2016 / 09 / 25  
Office & workshop area: 3,620 m2  
Number of Staff: 13,768



### Products / Services:



BB5- Replacment pump for Shazand Oil Refinery



Bouali Sina Petrochemical Project



Fire Fighting Container Package for MAPNA Combined Power Plants



ILAM SRU Project



Naein- Kashan- Rey Pipelien Project



OH2 Pump for Bouali Sina Petrochemical Company

### Products / Services:



OH2 Pump for Ilam SRU Project



BB3 Pumps for Bouali Sina petrochemical Project



Pitot Tube Pump (OH6 Type) for Shiraz Petrochemical Company



Replacment pump for Aryasol Polymer Company



VS4 Pump for Bouali Sina Petrochemical company

Tel: +98 21 44239645  
Fax: +98 21 44275347  
E-mail: [office@mrpaco.ir](mailto:office@mrpaco.ir)  
Web: [www.mrpaco.ir](http://www.mrpaco.ir)  
Address: No4. Isar street. Marzdaran Blvd.  
Tehran. Iran



VS6 pump for Ilam SRU project in test stand



## Machine Sazi Arak Knoledge - Based Company

Founded date: 1967 / 04 / 04  
Office & workshop area: 1,340,000 m2  
Number of Staff: 1,500 or more



### Products / Services:



Arch bridges-Izeh



Casting



Fire Tube Steam Boilers and Hot Water Boilers



H.P. TYPE INCINERATORS RANGE 150 TO 1000  
KG-H TECHNICAL FEATURES



Masjed Soleiman Dam and Power Plant



shipunloader

### Products / Services:



Steel Structures-Aftab



X-MAS TREE & Tubing Head Spool4( 1-16 Inch)-  
5K-MC FF



Flange



Direct gas heaters



Reactors

Tel: +98 86 33130031 - 9 +98 21 44279775 - 6  
Fax: +98 86 3313020 +98 21 44275715  
E-mail: [info@msa.ir](mailto:info@msa.ir)  
Web: <http://www.msa.ir>  
Address: Main office and factory: Sanaat Sqr.,  
Arak, Iran.  
P.O.Box:148, Postal Code:3818997888  
Tehran Office: No.4, 2nd Namdar, Isar St.,  
Marzadaran Ave., Tehran, Iran



Direct Gas Heaters





## Mahdin Industrial Company

Founded date: 1997  
Office & workshop area: 65,000 m2  
Number of Staff: 140



### Products / Services:



Deaerator phase12

All kinds of mechanical fixed equipment such As pressure vessels, heat exchangers, drums, towers, reactors, pig L/R columns, deaerators (steam, vacuum)  
Storage tanks (double wall, cryogenic)  
Process package (fine filter, backwash), chemical injection package)



### Products / Services:



Bidboland II



Isfahan Refinery

Tel: +98 21 22091809  
Fax: +98 21 22342991  
E-mail: [info@mahdinind.com](mailto:info@mahdinind.com)  
Web: [www.mahdinind.com](http://www.mahdinind.com)  
Address: 2nd floor. No.1 corner of pir bastami alley,  
dashte behesht st., 24th blvd., saadat abad,  
Tehran-iran

## Mahshahr Pipe Protection Co.

Founded date: 2003 / 09 / 29  
Office & workshop area: 370,000 m<sup>2</sup>  
Number of Staff: 450



### Products / Services:



External Anti-Corrosion Pipe Coatings



Internal Pipe Coatings



High-Temperature & Thermal Insulation Coatings

### Products / Services:



Offshore Coatings



Custom Coating of Non-Tubular Products



On-Site Field-Joint Coatings and Rehabilitation

Tel: +98 21 88 88 26 81 - 82  
Fax: +98 21 88 67 82 77  
E-mail: office@mppc.ir  
Web: www.mppc.ir  
Address: 2nd Floor, No. 398, Mirdamad Blvd, Tehran - Iran

## Mangan Manufacturing Company

Founded date: 1985 / 05 / 16

Office & workshop area: 12,000 m2

Number of Staff: 153

Know How Compilation, Design, Manufacturing, Installation and After Sales Services:  
All types of Turbo Machines, Material Handling, Cranes, Standard Component



### Products / Services:



axial fan



centrifugal compressor



Double Boom Crane



Explosion Proof Crane



Harbor Mobile Crane

### Products / Services:



Offshore crane

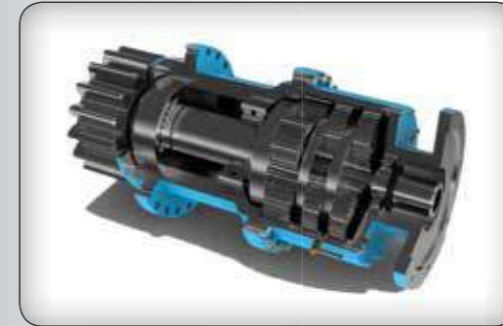

Planetary Gearbox



stacker&reclaimer



Transtainer



unloader



Tel: +98 21 66803364  
Fax: +98 21 66801375  
E-mail: [info@mangan-co.com](mailto:info@mangan-co.com)  
Web: [www.mangan-co.com](http://www.mangan-co.com)  
Address: NO.401, Hefdah Shahrivar Ave., Km 5 Old Karadj Road Tehran-Iran  
PO Code: 13787-56111

## Mapna Boiler & Equipment Engineering and Manufacturing Co.

Founded date: 1999  
Office & workshop area: Head office: 4,500 m<sup>2</sup>    Factory: 100,000 m<sup>2</sup>  
Elahieh Complex: 220,000 m<sup>2</sup>  
Number of Staff: 1,166



### Products / Services:



Heat Recovery Steam Generators (HRSG)  
Yazd Taban Combined Cycle Power Plant



Package/Industrial Boilers  
Fajr 2 Petrochemical Project



Conventional Boilers



CHP Boilers  
Qeshm power and water plant



Water Treatment Package  
West Karoon WTP Project



Sea Water Desalination System

### Products / Services:



De-aerator  
Phase 15&16 South Pars plant



Heat exchangers



Pressure Vessel & Strong Tank



De-Oiling  
Phase 15&16 South Pars plant



Services: Erection & commissioning - Inspection -  
Performance Test - Maintenance & Repairs - Overhaul  
- Repowering - Spare Part Delivery - Engineering,  
Consultation - Operators' Training

Address: No. 7, Golkhane alley, Africa St., Tehran, Iran. Post Code: 1915843611  
Tel: +98 21 27582424  
Fax: +98 21 27582001  
Factory Address: Kavosh blvd. , 12km of Qazvin-Karaj highway, Iran. Post Code: 3365166341  
Tel: +98 21 27583900  
Fax: +98 26 92108043  
E-mail: mailbox@mapnabe.com  
Web: www.mapnabe.com



## Mapna STS Co.

Founded date: 1996  
Office & workshop area: 300,000 m<sup>2</sup>  
Number of Staff: 620



### Products / Services:



Equipment of Thermal Power Plants



Equipment of Hot Section



ACC-Dry Cooling Systems  
Parand Combined Cycle Power Plant



HELER -Dry Cooling Tower  
Jahrom Combined Cycle Power Plant

### Products / Services:



Thermal Desalination Plant(MED-TVtype)  
Qeshm water and power plant



Wind Turbine Tower  
Kahak wind farm



Parallel Flow Regenerative Shaft  
yazd

Tel: +98 31 45233271  
Fax: +98 31 45233272  
E-mail: Pouladi.kimia@Mapnasts.com  
Web: www.mapnasts.ir  
Address: Esfahan -Tehran highway- Bozorge Esfahan industrial zone

## MAPNA TURBINE ENGINEERING & MANUFACTURING Co. (TUGA)

Founded date: 1999 / 06 / 22  
Office & workshop area: 157,214 m<sup>2</sup>  
Number of Staff: 1,593



### Products / Services:



MGT-30 ( 25 MW )  
National Iranian Gas Co. Pars Oil and Gas Co.  
Thermal Power Plants Holding ( Total : 88 Units )



MGT-40 ( 42 MW )  
Zahedan Power Plant



MGT-70 (185 MW) Iraq: Alsadr & Najaf & Rumaila P.P.  
Syria: Jandar & Tishreen P.P. Iran: Damavand,  
Kerman, Kazeron, Sanandaj and ... (Total: 147 Units)

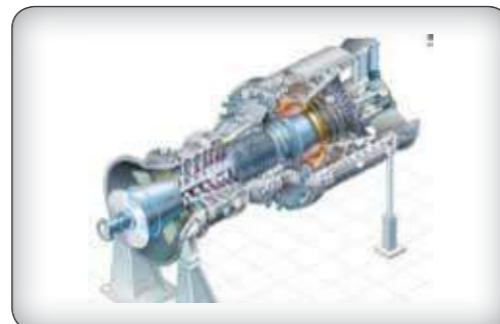

MGT-80 (308 MW)  
Hengam Power Plant (Bandar Abbas)



AVON 1535 (Refurbishment & Spare Parts)  
National Iranian South Oil Company (Total : 3 Units)

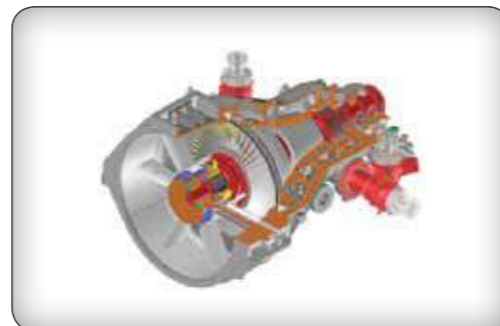

MST-50 C (159 MW) Iraq: Rumaila P.P.  
Syria: Jandar & Tishreen P.P. Iran: Damavand,  
Kerman, Kazeron, Sanandaj and ... (Total : 48 Units)

### Products / Services:



MST-70 (320 MW)  
Hengam Power Plant (Bandar Abbas)

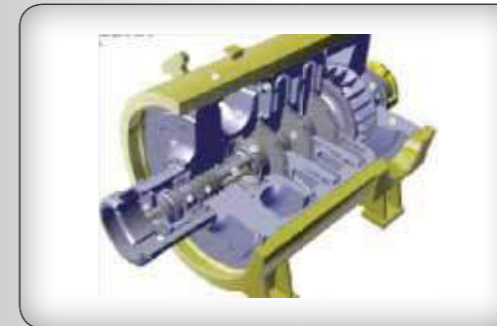

Centrifugal Compressor  
National Iranian gas Co. Pars Oil and Gas Co.



Gearboxes (Wind Turbine & ACC Gearbox)  
Kahak and Agh-kand Wind Farm (Total: 35 Units)  
Ferdousi, Assaluyeh , Parand and ... (Total : 56 Units)



Overhaul, Repair and Maintenance of various types of Gas  
turbines and Steam turbines. Avon 1535 (NISOC) Shinko  
(NITC) MGT30- DU80 (NIGC & PARSIAN Refinery)



Engineering and Manufacturing of all types of Gas and  
steam turbines Blades  
Compressor blades for Gas turbines & Steam turbine

Head Office Address: 231 Mirdamad Ave. Tehran - I.R.Iran. P.O.Box: 158755643  
Tel : +98 21 22908581  
Fax: +98 21 22908654  
Factory Address: Mapna blvd., Fardis, Karaj, I.R.Iran. Postcode:3167643594  
Tel: +98 26 36630010  
Fax: +98 26 36612734  
Web: www.mapnaturbine.com  
E-mail: info@mapnaturbine.co.ir

## Mashal Kaveh

Founded date: 1982 / 07 / 31  
Office & workshop area: 135 m2 - 10,000 m2  
Number of Staff: 37



### Products / Services:



Gas burner Type: UDGL600  
Capacity: 4000000 kcal/h On panel furnace  
Project name: Sepehr Varz Project location: Ahar



Gas-oil burner On hot oil furnace  
Type: UDGL600 Capacity: 4000000 kcal/h  
Project name: wood and chip point Project location: Semnan



Gas-oil burner Type: UDGL600  
Capacity: 4000000 kcal/h On pot Dabo Sanat  
Project location: mehr abad airport



Gas-oil burner Type: UDGL250-1  
Capacity: 1800000 kcal/h On horizontal hot oil furnace  
Project location: Booshehr Petro rama company

### Products / Services:



Gas-oil burner Type: MF GL 500  
Capacity: 3500000 kcal/h Coroz company



Gas-oil burner Capacity: 800000 kcal/h  
Type: MFL100-100 On hot furnace  
Project location: Coveit Company: KMB



Gas-oil burner Type: MFGL800  
Capacity: 6000000 kcal/h On pot abbant  
Project location: Shahrood Company: miami cheese



Gas-oil burner Type: MFGL800  
Capacity: 6000000 kcal/h On pot abbant  
Project location: Shahrood Company: miami cheese



Three Gas burner Type: MFG500 Capacity: 3500000 kcal/h  
Project name: commercial complex  
Project location: Mah shahr

Tel: +98 21 88300361  
Fax: +98 21 88307375  
E-mail: mashalkaveh@yahoo.com  
Web: WWW.mashalkaveh.com  
Address: No38, opposite to Zohreh forced way, Modarress Highway  
Tehran - Iran

## Masnouat Felezi Sangin

Founded date: 1989 / 07 / 29  
Office & workshop area: 22,300 m2  
Number of Staff: 293



### Products / Services:



Deaerators (Manufacturing of Deaerator for Persian Gulf Star Gas Condensate Refinery)



Electrostatic AC/DC Desalters (Manufacturing of Desalters for Marun Desalting Unit 1 & 4)



Direct Fired Heaters (Manufacturing of Direct Fired Heater for Shourijeh Gas Storage Facilities)



Flare Stacks & Incinerators (Manufacturing of Flare Stack for Di- Polymer Arya Petrochemical Plant)



Shell & Tube Heat Exchangers (Manufacturing of Shell & Tube Heat Exchangers for Masjed Soleiman Petrochemical, Urea & Ammonia Plant)



Indirect Heaters (Manufacturing of Indirect Heater for Haftkel Desalting Unit)

### Products / Services:



Process Packages & Skids ( Manufacturing of Gas Dehydration Package for Abuzar Oil Platform)



Pressure Vessels, Towers & Reactors (Manufacturing of Tower for Nouri Petrochemical -LTE Plant)



Multi Cyclone Scrubbers (Manufacturing of Scrubbers for Pataveh Gas Compressor Station)



2 Phase Separators (Manufacturing of 2 Phase Separators for Kharg Island Gas Gathering & NGL Recovery Project)



Spherical & Double Wall Tanks (Manufacturing of Spherical Tanks for Ilam Gas Refinery)

Tel: +98 21 44222415 / 44247065 / 44248214 / 44248212 / 44254215 / 44254202 / 44223160  
Fax: +98 21 44239851  
E-mail: [MFS@MFS-CO.COM](mailto:MFS@MFS-CO.COM)  
Web: [WWW.MFS-CO.COM](http://WWW.MFS-CO.COM)  
Address: First Flr., No.119, Ashrafi Esfahani Highway., 2nd Sadeghiyeh Sqr., Tehran, Iran



Fixed & Floating Roof Storage Tanks (Manufacturing of Floating Roof Storage Tanks for Boali Sina Petrochemical Plant)



## Momtaz Pump Co.

Founded date: 1985 / 06 / 22  
Office & workshop area: 5,000 m2  
Number of Staff: 50



Production of vertical turbine pumps and motors vertical hollow shaft

### Products / Services:



Khuzestan Water & Power Authority



Chabahar Shilat ORG (sea water)



Ahvaz Water & Waste Water Co.



Alborz Province Water & Waste Water Co.



Dezfool Water & Waste Water Co.



Qazvin Province Water & Waste Water Co.

### Products / Services:



East Tehran Water & Waste Water Co.



South Kaveh Steel Co. (sea water)



Bushehr Province Department Of Ports And Maritime Organization (sea water)



Lorestan Agricultural Jihad Organization



Mobarake Steel Co.



Tel: +98 21 66804975 - 6  
Fax: +98 21 66803119  
E-mail: info@momtazpump.com  
Web: www.momtazpump.cpm  
Address: Navard Ave. Nearby Kan bridge.Fath highway. Tehran  
Zipcode:1378754411

## Navid Sahand Pump Manufacturing Industries Co.

Founded date: 1997 / 10 / 14  
Office & workshop area: 23,200 m<sup>2</sup>  
Number of Staff: 86



### Products / Services:



OH1 Pump With API-610 Standard



OH2 Pump With API-610 Standard



BB1 Pump With API-610 Standard



BB2 Pump With API-610 Standard

### Products / Services:

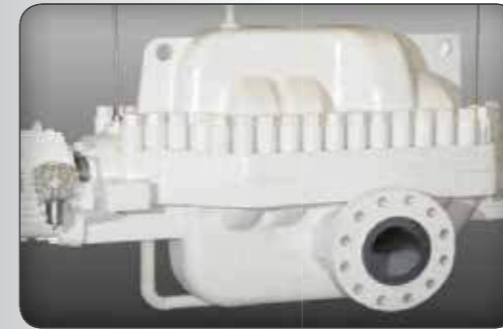

BB3 Pump With API-610 Standard



BB4 Pump With API-610 Standard



VS1 Pump With API-610 Standard



VS4 Pump With API-610 Standard



Slurry Pump With ISO 5199



Tel: +98 21 22 25 8285 - 7  
Fax: +98 21 22 25 8288  
E-mail: [Info@navidsahand.com](mailto:Info@navidsahand.com)  
Web: [www.navidsahand.com](http://www.navidsahand.com)  
Address: No. 15, 4th floor, East entrance, Arian Tower, No. 228, Mirdamad Blvd.  
Tehran, Iran

## Niroumoharekeh Machine tools Co.

Founded date: 1992 / 03 / 18  
Office & workshop area: 5,410 m2  
Number of Staff: 25



### Products / Services:



Complete Paint Shop (PT&ED)  
Bahman Diesel PT & ED Line



Municipal Waste Processing  
Tehran municipality waste management

### Products / Services:



Material Handling System  
Shahid Bahonar copper  
Ind. Co. Kerman



Air Handling Unit & Heat exchanger  
Saipa Citroen Co.

Tel: +98 28 33297616 - 25  
Fax: +98 28 33297615  
E-mail: [info@nmt-co.com](mailto:info@nmt-co.com)  
Web: [www.nmt-co.com](http://www.nmt-co.com)  
Address: Beginning of Alborz Industrial Road Blvd, Ghazvin - I.R.IRAN  
P.O.BOX 1519

## OMRAN TAHVIEH Co.

Founded date: 2009 / 06 / 11  
Office & workshop area: 12,500 m2  
Number of Staff: 90



### Products / Services:



AIR COOLED CHILLER - OIL & CHEMICAL INDUSTRIAL



AIR COOLED CHILLER - OIL & CHEMICAL INDUSTRIAL



Modular Packaged Air. Conditioners



Hygienic Air Handling Unit



### Products / Services:



Air Washer section



DUST PROOF COOLING TOWER

Tel: +98 21 22324378 - 9  
Fax: +98 21 22530959  
E-mail: [info@omrantahvieh.com](mailto:info@omrantahvieh.com)  
Web: [www.omrantahvieh.com](http://www.omrantahvieh.com)  
Address: No:4, Bahar Dead-end, Baharan Alley, Maleki nasab St, keshvari St, Araghi St, 2nd Boustan, Pasdaran, Tehran.

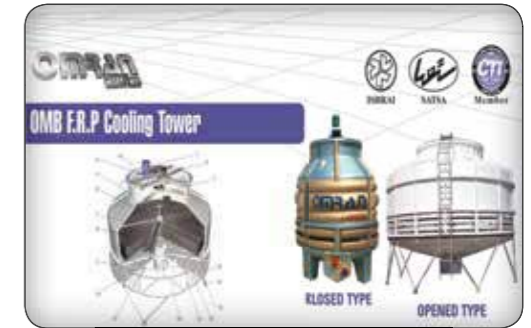

F.R.P. COOLING TOWER



DUST PROOF COOLING TOWER

## Packman

Founded date: 1976 / 01 / 29  
Office & workshop area: 77,400 m2  
Number of Staff: 630



### Products / Services:



Three Pass Steam Boiler & Other Boiler Room  
Accessories  
Parand Combined Cycle Power Plant



Three Pass Hot Water Boiler  
Irankhodro Factory (Khorasan)



Vertical Steam Boiler  
Moheb Kosar Hospital



Thermal Oil Heater  
Fooman Shimi Main Factory



Condensing Boiler  
Arta Jooje Farm (Ardebil)



CHP  
Nirooterans Factory (Shiraz)

### Products / Services:



Water Softener  
Behnoosh Iran Co.



Domestic Hot Water, Boiler & Other Boiler Room  
Accessories  
West Mazandaran Combined Cycle Power Plant



Blowdown Tank, Boiler & Other Boiler Room  
Accessories  
Mapna Power Plants Development Company  
-Roodeshoor Project

Tel: +98 21 42362  
Fax: +98 21 88737131  
E-mail: [info@packman.ir](mailto:info@packman.ir)  
Web: [www.packmangroup.com](http://www.packmangroup.com)  
Address: 4th Floor, No .2, 10th Street,  
Bokharest ave, Tehran-Iran.



Condensate Tank, Boiler & Other Boiler Room  
Accessories  
Rosemond Petrochemical Of Bushehr



Heat Exchanger, Boiler & Other Boiler Room  
Accessories  
Opark Water Park (Tehran)



Deaerator, Boiler & Other Boiler Room  
Accessories  
Combined Cycle Power Plant Damavand

## PAKFANBOKHAR

Founded date: 1999 / 01 / 27  
Office & workshop area: 8,720 m<sup>2</sup>  
Number of Staff: 73



### Products / Services:



Three pass wet back steam boiler



Three pass dry back steam boiler



Vertical steam boiler



Three pass wet back hot water boiler



Three pass dry back hot water boiler



Reverse flame hot water boiler

### Products / Services:



Firebox hot water boiler



Oil heater boiler



Deaerator



Water softener



Sand filter

Tel: +98 8131444  
+98 8138252500  
+98 8138253000  
Fax: +98 8138254216  
E-mail: pakfan.info@gmail.com  
Web: www.pakfan-boiler.com  
Address: Number 524 - boali street - Hamedan



Horizontal tank heater

## PANTAN

Founded date: 2001 / 06 / 03  
Office & workshop area: 20,000 m<sup>2</sup>  
Number of Staff: 80



### Products / Services:

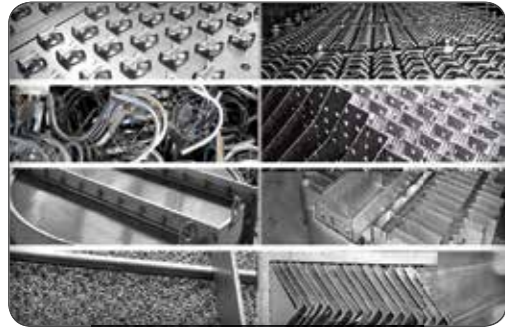

Process Vessel, Drums (Separators) and Reactor Internals



Engineering services for performance improvement or capacity enhancement in in distillation and separation processes as Revamping



### Engineering and Manufacturing of Packages:

- Gas Separation
- Gas Sweetening
- Gas Dehydration
- Multiphase Separation
- Solvent Recovery
- Deaerator
- Cyclone
- Static Mixer

### Products / Services:



Small Pressure Vessel and Heat Exchanger Manufacturing



Supply and Manufacturing of spare parts related to Process Vessel, Separators and Reactor Internals



Installation and Installation supervision services

Tel: +98 21 88370266  
Fax: +98 21 88370267  
E-mail: [info@pantan.co](mailto:info@pantan.co)  
Web: [www.pantan.co](http://www.pantan.co)  
Address: 5th floor, No. 192, Darya Blvd., Saadat Abad,  
Tehran, Iran

## Pars Sealing Systems Company (Burgmann Pars)

Founded date: 2002 / 06 / 18  
Office & workshop area: 3,500 m2  
Number of Staff: 110



### Products / Services:



Mechanical Seal



Dry Gas Seal



Mechanical Seal Supply Systems

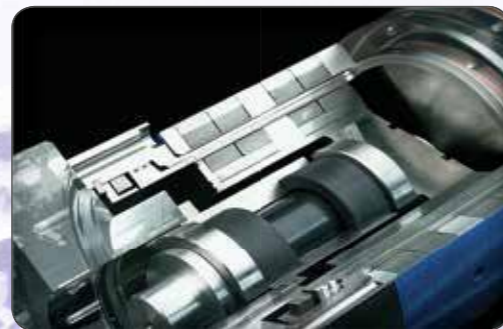

Magnetic Coupling

Our Products are installed in all sites in which pumps and compressors are working now.  
Our main customers are: oil refineries, gas refineries, petrochemical industries,  
steel manufacturers, pulp & paper manufacturers, food industries, power plants.

### Products / Services:



Expansion Joints (Rubber, Metal, Fabric)



Flexible Hoses (Rubber, Metal)



Gasket (Spiral Wound)



Packing



Before, While & After Sales Services

Tel: +98 21 44525230  
Fax: +98 21 44534041  
E-mail: sales@parsseal.com  
Web: www.parsseal.com  
Address: No.10, Ta'avon Blvd. Nakh e Zarrin Blvd. Km.09 Tehran - Karaj Road (Makhsous).  
Tehran, 1389717531, Iran



## Pars Vacuum Industries

Founded date: 1985 / 08 / 18  
Office & workshop area: 44/2807 m2  
Number of Staff: 65



### Products / Services:



All Vacuum Pumps Including: Liquid Ring, Screw Vacuum, Rotary Vane, Rotary Piston, Vacuum Booster (According to API 681)



All Air & Gas Blower Including: Roots Type, Screw Blower, Turbo Blower, Multistage Centrifugal Blower



All Air & Gas Compressor Including: Liquid Ring, Screw Compressor, Centrifugal Compressor (According to API 619)



### Products / Services:



Centrifugal Pumps for Process Applications in Oil, Gas and Petrochemical. (According to API 610)



Design & producing engineered Vacuum- Compressor System in oil& Gas and Petrochemical

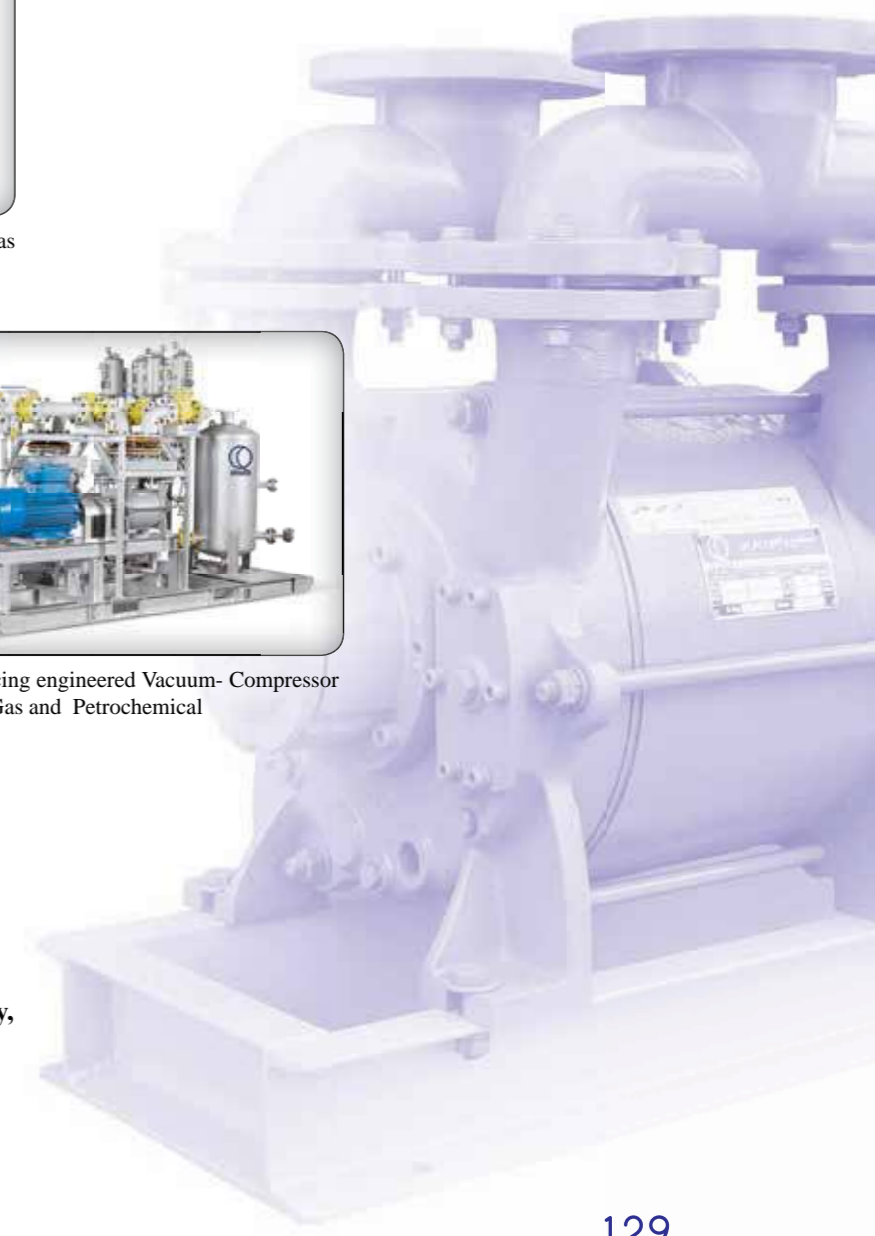

Tel: +98 21 66801373  
Fax: +98 21 66806659  
E-mail: [info@parsvacuum.com](mailto:info@parsvacuum.com)  
Web: [www.parsvacuum.com](http://www.parsvacuum.com)  
Address: No.26, 21 Fathe St, Fath Highway,  
Tehran, Iran

## Pars Zagros Heavy Machinery Co.

Founded date: 1996  
Office & workshop area: 51000 m2  
Number of Staff: 45



### Products / Services:



Steel Coil Inspection Lines (EPC Contract)



Steel Coil Packing Line (EPC Contract)



Two Friction Saw Lines (EPC Contract)



Continues Casting Machine (CCM) (EP Contract)



Slitting Line



ERW (Electric Resistance Welding) Steel Tube Mill

### Products / Services:



Pipe End-Facing & Beveling Machine



Pipe Hydro-Testing Machine



Pipe Threading Machine



Hydraulic Power Pack & Manifold Blocks, Hydraulic & Pneumatic Cylinders



Gearboxes



Tel: +98 31 5237 3510 +98 31 5237 3218  
Fax: +98 31 5237 3509  
E-mail: info@psrolling.com  
Web: www.psrolling.com  
Address: Pars Zagros Heavy Machinery Co.  
Mobarekeh Industrial Zone 8486133336 Isfahan Iran  
P.O. Box: 84815-511

## Paya Sanat Ahwaz

Founded date: 2003 / 11 / 18  
Office & workshop area: 10,000 m<sup>2</sup>  
Number of Staff: 50



### Products / Services:



Pump Truck



Mobile Oil Separator (MOS)



Mobile Oil Separator (MOS)

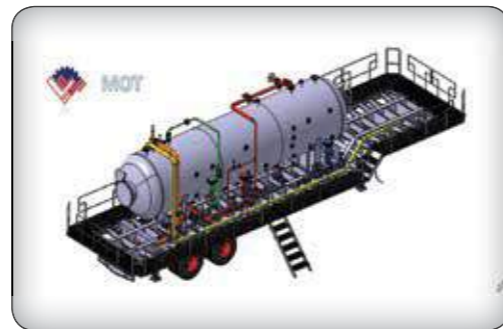

Mobile Oil Treatment (MOT)



Coiled Tubing Unit

### Products / Services:



20000 Gallon Tank



Acid Tanker



Pump Truck



Solution Tank



500 BBL Acid Tank



Tel: +98 61 34474545  
Fax: +98 21 89783273  
E-mail: [paya\\_sanat\\_ahwaz@yahoo.com](mailto:paya_sanat_ahwaz@yahoo.com)  
Web: [www.payasanat.net](http://www.payasanat.net)  
Address: After Sheiban Bridge - 12th Km Masjid Soleyman Road – Ahwaz

## Paysaz Co.

Founded date: 1967  
Office & workshop area: 133,762 m<sup>2</sup>  
Number of Staff: 205



### Products / Services:



Storage Tank – NGL3200 - PEDEC



Surge Tank – Persian Gulf Water Transmission – WAS Co.



Storage Tank (Internal Floating Roof) – Buali Sina Petrochemical



Scrubber – Asmari Marun 5 - NISOC



Drum – Olefin Unit - Gachsaran Petrochemical



Separator - Asmari Marun 3 - NISOC

### Products / Services:



Tower – Buali Sina Petrochemical



Desalter – Phase 17 & 18 of South Pars - POGC



Heater – Ahwaz Desalting Plant - NISOC



Huge Column - Abadan Refinery - NIOEC



Heat Exchanger - Abadan Petrochemical

### Head Office:

Tel/Fax: +98 21 88901723 +98 21 88905921  
+98 21 88938381 +98 21 88937459

Address: 6th Floor, No.7 Shadab St.  
Sepahbod Gharani St. - Tehran – Iran

### Factory:

Tel: +98 61 33313100-4  
Fax: +98 61 33313201

Address: 7th Km.Ahwaz-Khorramshahr  
Road Ahwaz – Iran P.O Box : 61436-1570

E-mail: [info@paysaz.com](mailto:info@paysaz.com)

Web: [www.paysaz.com](http://www.paysaz.com)



Stack & Duct – Sarcheshmeh Copper - NICICO



## Petro Foolad Jahan Co.

Founded date: 2012 / 10 / 06  
Office & workshop area: 45,000 m2  
Number of Staff: 120



### Products / Services:



Pipe rack



Handrail & ladder & other accessory



Guard rail

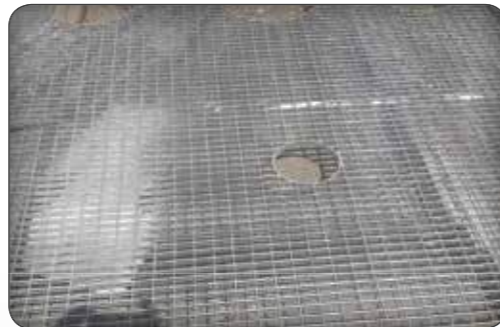

grating

### Products / Services:



Bracket & hook



Plat form



bridge



Storge tank

Tel: +98 21 27624241 +98 21 65432476 +98 21 65432441  
Fax: +98 21 65432477  
E-mail: [info@petrofoolad.com](mailto:info@petrofoolad.com)  
Web: [www.petrofoolad.com](http://www.petrofoolad.com)  
Address: Tehran, Safadasht Industrial Estate, End of West 1st Street, No. 204

## Petro Pump Engineering Design and Manufacture

Founded date: 2001 / 02 / 27  
Office & workshop area:  
Office (62 m2) & workshop (4,323 m2)  
Number of Staff: 55



### Products / Services:



Centrifugal Pump Type BB1

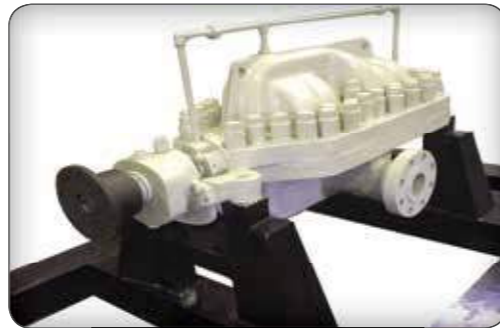

Centrifugal Pump Type BB3



Centrifugal Pump Type OH2



Centrifugal Hot Oil Pump



Centrifugal Slurry Pump



Reciprocating Triplex Plunger Single Acting Pump

### Products / Services:

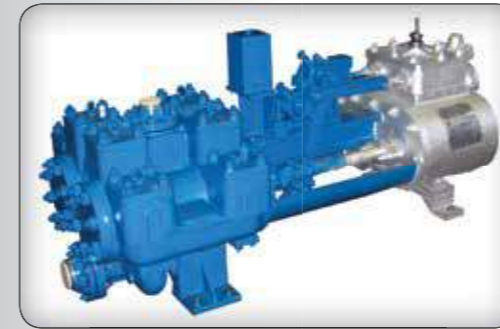

Reciprocating Steam Driven Duplex Double Acting Pump



Reciprocating Triplex Plunger Pump



Reciprocating Double Acting Piston Pump



Petro Fire Pump



Trash Pump

Tel: +98 21 88086883  
Fax: +98 21 88086891  
E-mail: [info@petropedam.com](mailto:info@petropedam.com)  
Web: [www.petropedam.com](http://www.petropedam.com)  
Address: Golbon 12th st., Boustan Blv.,  
Shamsabad Industrial Area, After IKIA  
Tehran – Ghom Highway, Tehran , Iran



Special Mobile Sewage Pump

## Petrochemical Industries Design Equipment & Parts Manufacture Company

Founded date: 1994 / 08 / 03  
Office & workshop area: 18,000 m<sup>2</sup>  
Number of Staff: 150



### Products / Services:



Hydrogenation Reactor  
Client : Esfahan Oil Refining Company (EORC)



Isomax Tower Revamp  
Client : Tehran Refinery Company



Shell & Tube Heat Exchangers  
Client : Esfahan Oil Refining Company (EORC)



Transfer Line Exchanger (TLE)  
Client : Amir Kabir Petrochemical Company  
Marun Petrochemical Company



Converter & Heat Exchangers of Acid Plants  
Client.: Sarchesmeh & Katoon Abad Sulphuric Acid  
Plants.



Shell & Tube Heat Exchanger.(AEL with Rod Baffles)  
Client.: Amir Kabir Petrochemical Company

### Products / Services:



Cladding of Equipment



Machinery Service



Construction and supply of Tower & Reactor  
Internal Parts and Accessories



Industrial Gasket  
Fabrication  
PIDEMCO/PARSFLEX



Construction and supply of Tower & Reactor  
Internal Parts and Accessories

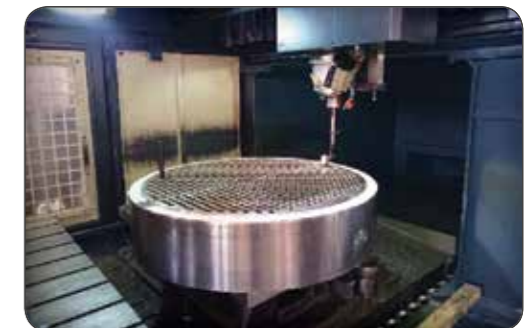

Machinery Service



Tel: +98 21 46830200 - 208  
Fax: +98 21 46830209  
E-mail: [Info@pidemco.com](mailto:Info@pidemco.com)  
Web: [www.pidemco.com](http://www.pidemco.com)  
Address: No.33 Sanat yekom Str. Enghelab  
Blvd, Ghods city , 20Km Karaj old road ,  
Tehran , Iran

## Piramoan System Qeshm

On-line Analyzer System manufacturer for Oil, Gas, Petrochemical Plants  
CEMS and SWAS Analyzers for Power Plants

Founded date: 2007 / 11 / 01

Office & workshop area: 540 & 570 m2

Number of Staff: 102



### Products / Services:



Continuous Emission Monitoring System/Flue  
Gas Monitoring System



Sampling System/Steam and Water Analysis System



Liquid Analyzers (pH, Conduct, DO, Chlorine, Turbidity)



Waste Water Analyzers (TO, BOD, COD, TSS, ...)



### Products / Services:



BTU Analyzers/ Wobbe Index Analyzers



Gas Chromatograph Analyzer



Special analyzers (tail Gas, Moisture, ...)

Tel: +98 21 44444950  
Fax: +98 21 44612110  
E-mail: [commercial@piramoonco.com](mailto:commercial@piramoonco.com)  
Web: [www.piramoonco.com](http://www.piramoonco.com)  
Address: No.145, Mokhberi Blvd, Sattary  
Highway, Tehran, Iran



## Poolad Varzan-E- Kimia Co.

Founded date: 2003 / 12 / 24  
Office & workshop area:  
5,480 m2 as Work Shop / Total Area: 45,000 m2  
Number of Staff: 80



### Products / Services:



Air Cooled Heat Exchanger



Flare Equipment



Spiral Tube



U-Tube



Fin Tube

### Products / Services:



Plate Heat Exchanger



Shell and Tube Heat Exchanger



Tube Bundle



Tube Expanding Machine



Heat Exchanger



Tel: +98 713 6773235 - 8  
Fax: +98 713 6773239  
E-mail: [info@pooladvarzan.com](mailto:info@pooladvarzan.com)  
Web: [www.pooladvarzan.com](http://www.pooladvarzan.com)  
Address: K1-K10, Maloosjan Industrial Zone, Beyza,  
Shiraz - Iran

## Production Picture Of Iran

Founded date: 1969 / 07 / 02  
Office & workshop area: 1,500 m2  
Number of Staff: 50



### Products / Services:



Chemical Injection Package



Waste Heat Boiler



Flare Package



Glycol Dehydration Package



### Products / Services:



Oil Desalting Package



PLATE & FRAME



TEG Regeneration Package



Water Treatment Package

Tel: +98 21 88845038 +98 21 88845039  
Fax: +98 21 88343992  
E-mail: [Info@kavehmobadel.com](mailto:Info@kavehmobadel.com)  
Web: [WWW.MPI-KMC.COM](http://WWW.MPI-KMC.COM)  
Address: Unit3, no.154 Karim khan Ave. Tehran. Iran  
zip1584783617

## PUMPIRAN

Founded date: 1975  
Office & workshop area: 87,000 m2  
Number of Staff: 400



### Products / Services:



120 bar Process Water



Boiler Feed Pump



Double suction\_Horizontal



Double suction\_Vertical



High Delivery Water Transfer



High Press Process Pump

### Products / Services:



BB1 \_ Crude Oil Transfer



BB3 \_ Crude Oil Transfer



OH2 \_ 38 °C Hot Oil



OH3 \_ 28 °C Hot Oil



VS1 \_ Cooling Water



Tel: +98 21 88654811-4  
Fax: +98 21 88654814  
E-mail: [info@pumpiran.com](mailto:info@pumpiran.com) [Export@pumpiran.com](mailto:Export@pumpiran.com)  
Web: [www.pumpiran.com](http://www.pumpiran.com)  
Address: Second Eskin Tower, 1st Floor, Mirdamad Junction, Vali-E-Asr Ave.,  
Tehran-Iran

## Qeshm Offshore Free Ports & Industries

Founded date: 1997  
Office & workshop area: 570 m2  
Number of Staff: 139



### Products / Services:



Renew & Repair Project of Kharg Preparatory Harbor-  
Kharg Island



Breakwater & Wharf Construction- Sirri Island



Architectural & HVAC Project of SPQ1- South Pars  
Phase 1



Construction of Marine Pedestal Crane- South Pars  
Phases 4 & 5



Construction of Marine Pedestal Crane- Khazar Semi-  
Sub Drilling Unit



Construction of 2820 m3 Floating Roof Tanks-  
Kermanshah, Eslamabad & Ghasreshirin

### Products / Services:



Construction of 2820m3 Floating Roof Tanks- Zabol,  
Mahshahr, Kish, Bandar Lengeh & Qeshm



E.P.C. Construction of 5000 m3 Potable Water Storage  
Tanks- Lavan Island



Extension of Kharg Island Airport- Kharg Island



Complete Repair of 1 Million BBL No. 36 Storage  
Tank- Kharg Island



E.P.C. Construction & Installation of 6 Sets Storage  
Tanks- Zahedan, Yazd & Rafsanjan



Two Pantan Jetty Construction Project at Choebdeh &  
Arvandkenar- Choebdeh

Tel: +98 21 88375490 - 1  
Fax: +98 21 88375037 +98 21 88375034  
E-mail: info@saba-co.com  
Web: www.saba-co.com  
Address: Ario Building, North Falamak Ave,  
Ivanak Blvd. Shahrake-e-Ghods,  
Tehran, IRAN

## Radiran Mfg. Co.

Founded date: 1967  
Office & workshop area: 6,500 m2  
Number of Staff: 65



### Products / Services:

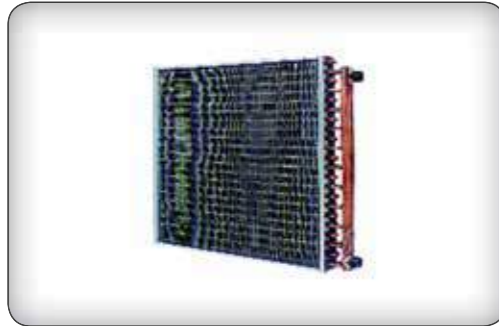

Various type of Fin & Tube heat exchangers



Industrial Dry Coolers



Industrial Hybrid Coolers



Shell & Tube Evaporator and Condensers

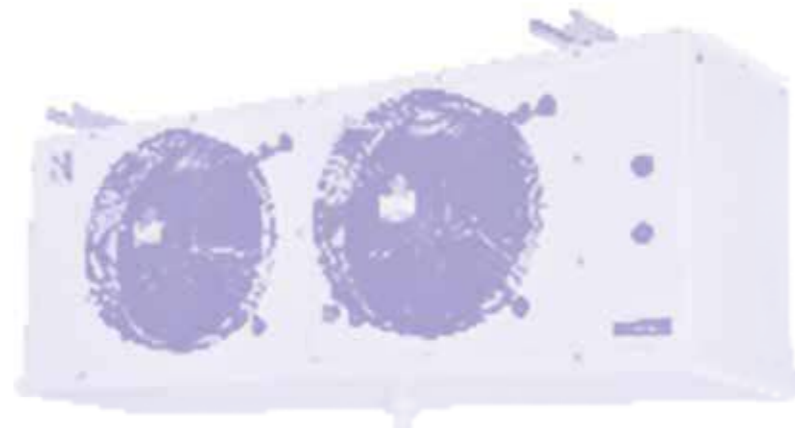

### Products / Services:



Refrigeration Condensing Units



Refrigeration Unit Coolers & Evaporators



Air Cooled Condenser Coils  
Unit Coolers  
Condensing Units

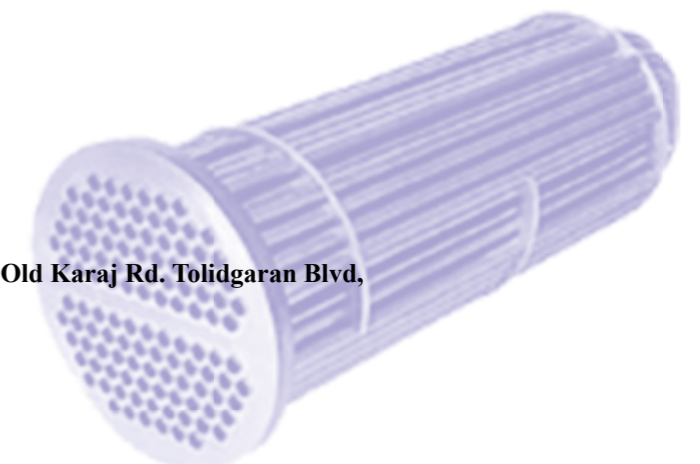

Tel: +98 21 46881980 to 4  
Fax: +98 21 46842292  
E-mail: [Info@radiran.com](mailto:Info@radiran.com)  
Web: [www.radiran.com](http://www.radiran.com)  
Address: Ghods Industrial Zone. 19th Km pf Old Karaj Rd. Tolidgaran Blvd,  
Fan Avaran St No. 2

## RASTA GROUP Industrial Valve MFG & DEV Co.

Founded date: 2001 / 05 / 08  
Office & workshop area: 5,000 m2  
Number of Staff: 89



### Products / Services:



Series AC3000 control choke valve  
Pressure class ANSI1500-2500  
Size 2" to 10"



AFR1000-Air Filter pressure Regulator  
Regulated pressure:0-100PSIG



Series BS9000 straight Through Ball valve  
Pressure class ANSI150-600  
Size 1/2" to 12"



Series BT8000, BT8200 Butterfly valves  
Pressure class ANSI150-600  
Size 3" to 64"



Series "D" Diaphragm and spring Actuators



Series GC1000Globe control valve  
Pressure class ANSI150-2500  
Size1" to 24"

### Products / Services:



Series GC2000Globe control valves  
Pressure class ANSI150-2500  
Size1" to 24"



Series GC3000Globe control valves  
Pressure class ANSI150-2500  
Size1" to 24"



Series GC1000Globe control valves  
Pressure class ANSI150-600  
Size1/2" to 8"



Series "P"  
Spring cylinder Actuator



Series "w"  
Diaphragm and Spring Actuators

Tel: +98 21 88307089  
Fax: +98 21 88307089  
E-mail: [Info@rastagroup.net](mailto:Info@rastagroup.net)  
Web: [www.rastagroup.net](http://www.rastagroup.net)  
Address: Unit 6, No. 35, South  
Kheradmand Street, Karimkhan Ave.,  
Tehran - IRAN

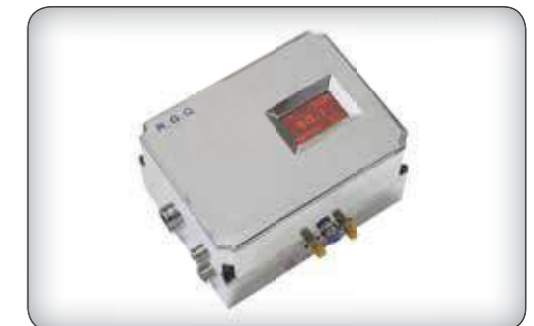

POP

## Rased Sanat Toseae

Founded date: 2004 / 08 / 12  
Office & workshop area: 43,659 m2  
Number of Staff: 108



### Products / Services:



Submerged and sludge electro-pumps



Industrial electro motors



Pool, water and wastewater treatment plants



Product & repair of different kinds of electro pumps



Hydraulic test kind of pump and electro pump



Consulting, Design, Construction & Maintenance of Different Kinds of Water Supply Systems and Networks Drainage

### Products / Services:



Cladding in wellhead equipment  
Cladding in Pressure Vessels, Towers, Heat Exchangers, ...  
Cladding in Pipeline and Piping Systems  
Cladding in all types of Flange and Fitting  
Production and Supplying of Welding Consumable

Tel: +98 61 33131728  
Fax: +98 21 89786898  
E-mail: rasedrst@gmail.com  
Web: www.rasedsanat.ir  
Address: km 18 road Ahwaz to Abadan-  
Ahwaz- Khuzestan-Iran



## Sabz Ashian APadana Eng. Co. (SAAPEC)

Founded date: 1996 / 10 / 01  
Office & workshop area: 25,000 m2  
Number of Staff: 750



### Products / Services:



Installation of Urea Unit of the 3rd Phase of The Pardis Petrochemical Company (Capacity One Million Tons Per Year)



Completion of Work, Pre-Commissioning & Punch List Removing and Start Up Units No 107,116,183 Of Phase 13 Of South Pars Refinery



Installation of Sulfur Solidification Unit (SSU) Of Gasoil Refinery Project of Isfahan Refinery Company



Construction & Installation & Pre-Commissioning of AG /UG Piping & Mechanical Equipment and BOG Unit of AGTP Petrochemical Co.

### Products / Services:



Construction of AG Piping, Civil, Steel Structure, Equipment of Apadana Petrochemical Co.



Construction of Two Sets of Staff Resorts of Kharg Petrochemical Co.



Fabrication and Installation of Steel Structure and Equipment of Several Power Plant in Iran



Implementation of Export Terminal of Kermanshah Petrochemical Complex As Turn Key

Tel: +98 31 36613933  
Fax: +98 031 36616510  
E-mail: [info@saapec.com](mailto:info@saapec.com)  
Web: [www.saapec.com](http://www.saapec.com)  
Address: 3rd Floor, Parsian Bldg., 14 Aly., Apadana Aval St., Isfahan, Iran  
Zip Code: 8165667805



## SADID Industrial Group

**Founded date: 1963**  
**Number of Staff: 2,500**

Sadid Industrial Group is considered the founder of machine industry, pipe and profile production, and casting in Iran. The group is currently accounted as one of the industrial holding companies in Iran, some of the subsidiary companies and field of activities are as follows.



### Products / Services:



Mahshahr Pipe Mill/ longitudinal Submerged Arced Welding pipes



Petco/ Heavy duty pumps and firefighting pumps and water turbines



Sadid Pipe & instrument company / Spiral type Pipes up to 120 inches in diameter



Saba Niroo Company/ Wind turbine manufacturing and design



Tasdid Offshore and Onshore development Co./ leading regional petroleum / energy (upstream /downstream) Services Company and EPC contractor



Gostaresh Steel Industries Company/ EPC/EPCF Contractor in steel, mine and construction sector

### Products / Services:



Sadid Tadbir Company / Financial services, stock exchange



Tavan Bad Company/ Wind farm developer and operator



Falegh Sanat Company/ Industrial General Contractor, Sugar Factories and Byproducts Industries



Sadid Oil& Gas Development Company / EPC contractor in oil and gas sector and trading services



Farab Company / Thermal Power Plants; Oil, Gas, and Petrochemical Projects; Water ( Wastewater Treatment Plants and Desalination, etc.)



**Tel: +98 21 22269993**  
**Fax: +98 21 26401402**  
**E-mail: info@sadid.ir**  
**Web: www.sadid.ir**  
**Address: No. 185 – Mirdamad Blvd. Tehran- Iran**

## Salafchegan Pipe and Protection Co.

Founded date: 1999 / 10 / 04  
Office & workshop area: 800,000 m<sup>2</sup>  
Number of Staff: 600



### Products / Services:



Steel Pipes for Oil, Gas and Water Transmission Lines and Structural Pipes

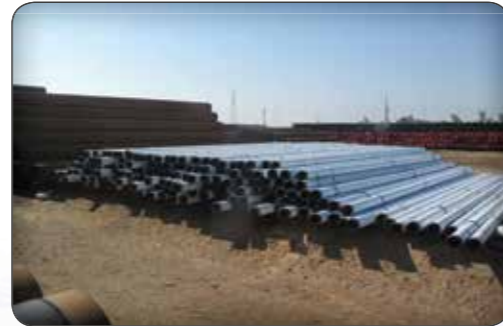

External Anti-Corrosion Pipe Coatings



Internal Pipe Coatings

### Products / Services:



High-Temperature & Thermal Insulation Coatings



Custom Coating of Non-Tubular Products



On-Site Field-Joint Coatings and Rehabilitation

Tel: +98 21 88773124  
Fax: +98 21 88874627  
E-mail: office@sppc.ir  
Web: www.sppc.ir  
Address: No. 4, Amdi alley, Mirdamad bridge, Africa highway Tehran, Iran.  
Zip Code: 1518954714

## SANAT KARAN BERMY Co.

Founded date: 1999 / 12 / 18  
Office & workshop area: 17,604 m2  
Number of Staff: The number of staff will be increased  
by 300 when it is necessary



### Products / Services:



Airport Crash Tender Fire engines



Dry Chemical Powder Vehicle



Electrical Hazards Operation Vehicle



Fire Engines for Refineries 2



Fire Engines for Refineries

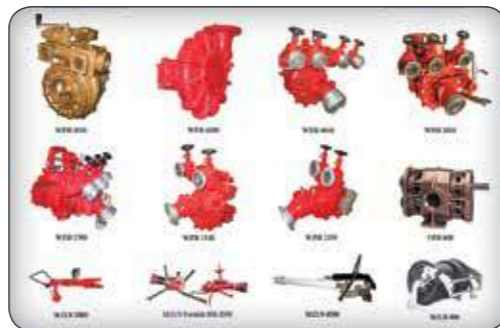

pumps and monitors

### Products / Services:



Relief and Rescue Vehicle 1



Relief and Rescue Vehicle 2



Relief and Rescue Vehicle 3



Trailer pump



Urban and Rapid Response Fire Vehicle 1



Address Factory: Deadend No#12, 11th  
Entry, Hashtgerd Industrial City, Alborz  
Province - Iran - Postal Code: 3361656379  
Tel: +98 26 44224388 Fax: +98 26 44225531  
Telegram: +98 901 2020321 (For Messaging Only)  
Address Tehran Office: Apt #6, 11th Floor,  
Iran Trade Center Bldg, No#216 Africa Blvd.  
- Tehran - Iran - Postal Code: 1966944877 -  
P.O.Box: 19395/4989  
Tel: +98 21 26212420 Fax: +98 21 26212419  
Email: [Info@bermyco.com](mailto:Info@bermyco.com)  
Web: [bermyco1@yahoo.com](mailto:bermyco1@yahoo.com)



Manufacturer of various types of fire trucks and related  
equipment

## SANATYARAN Co.

Founded date: 1984 / 09 / 29  
Office & workshop area: 6,240 m2  
Number of Staff: 52



### Products / Services:



Hepa & Ulpa

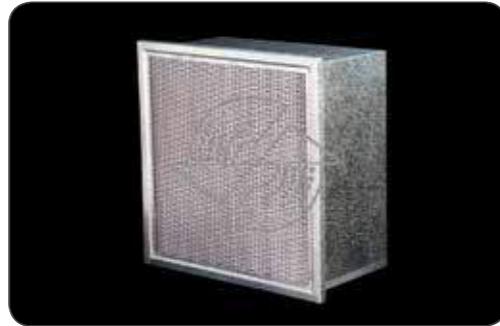

Varicell



Bag filters

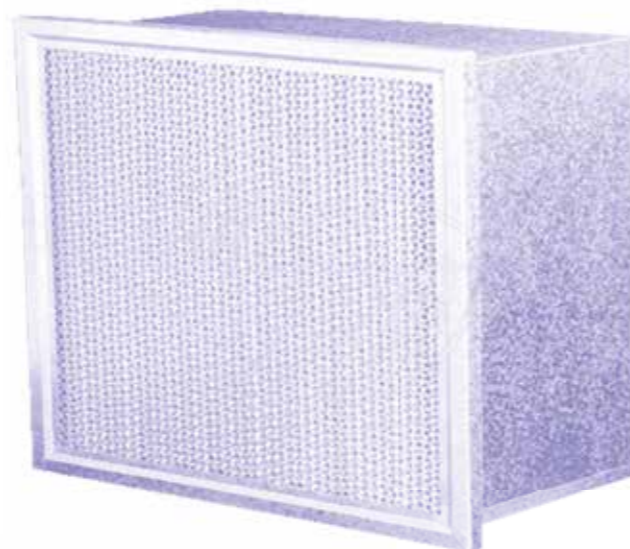
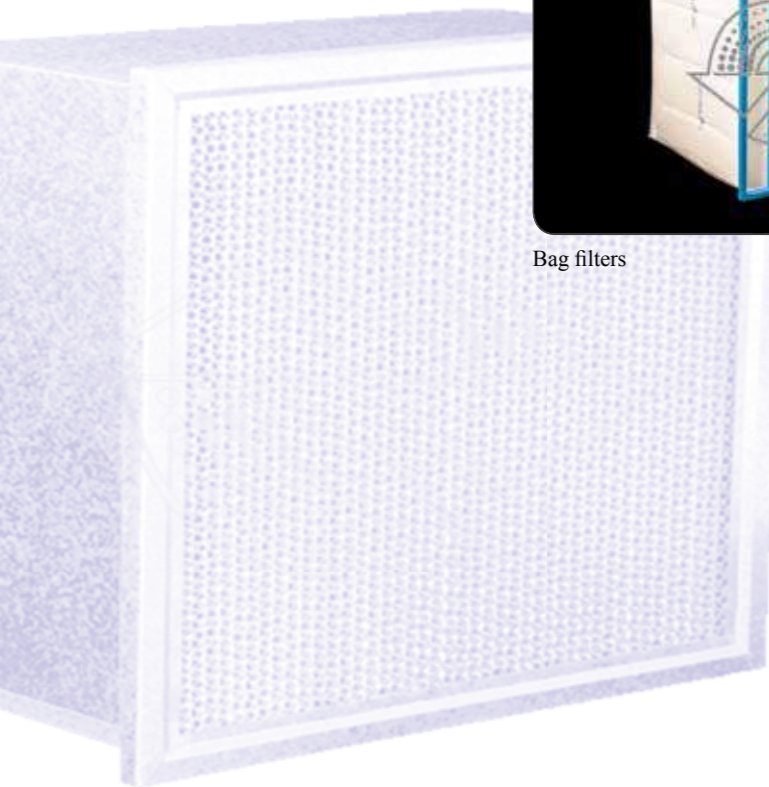

### Products / Services:

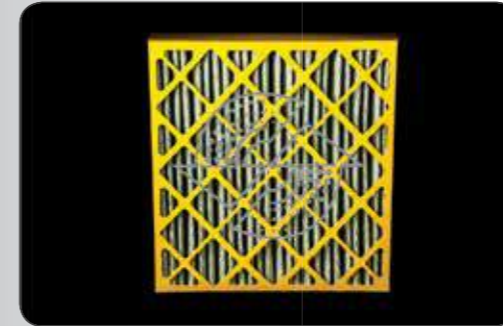

Prefilters



Rollomatic

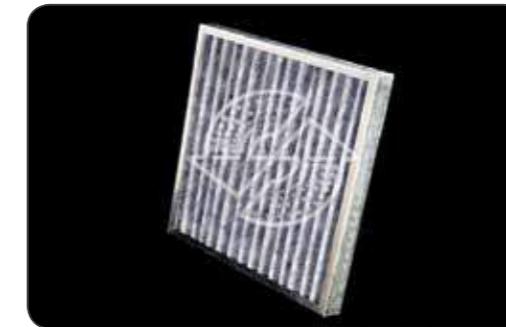

Carbon Active

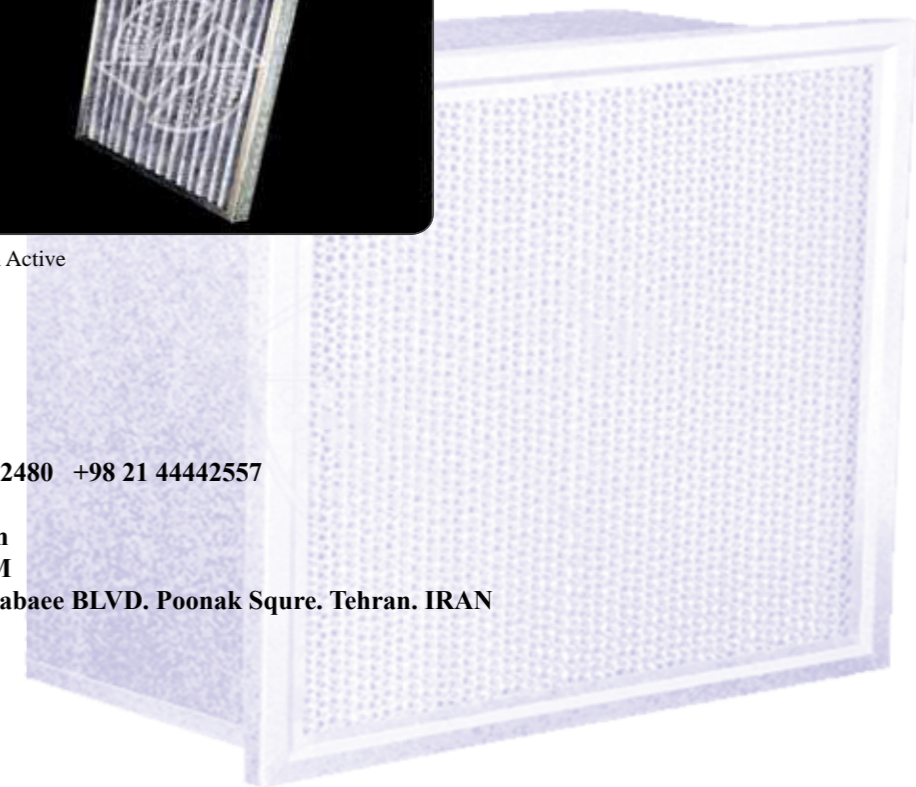

Tel: +98 21 44441772 +98 21 44442480 +98 21 44442557  
Fax: +98 21 44442394  
E-mail: [filters@sanatyan-IR.com](mailto:filters@sanatyan-IR.com)  
Web: [WWW.SANATYARAN.COM](http://WWW.SANATYARAN.COM)  
Address: No.55. Pak Alley. Mirzababae BLVD. Poonak Squire. Tehran. IRAN

## Sazvar Sazeh Azarestan

Founded date: 2010 / 10 / 12  
Office & workshop area: 42,000 m<sup>2</sup>  
Number of Staff: 700



### Products / Services:



Desalination Sand-Filter Tank – Bandar Abbas



Fabrication of steel structures of Bid Boland Mahshahr plant

### Products / Services:



Fabrication and installation of Steel structure of Main shop of Sangan Concentrate Project



Fabrication and installation of steel structures of Kermanshah petrochemical

Tel: +98 21 8796  
Fax: +98 21 88529349  
E-mail: [SazvarSazeh@azarestan.com](mailto:SazvarSazeh@azarestan.com)  
Web: [www.azarestan.com](http://www.azarestan.com)  
Address: Azarestan Bldg, No.5, 6th Alley, Koohe Noor St, Motahari Ave, Tehran, Iran.

## Shimi Azarjam

Founded date: 2004  
Office: Tehran/IRAN  
Workshop area: Shokouhieh industry zone/Qom/IRAN  
Number of Staff: 80



### Products / Services:



Glass Lined Reactors



PTFE Lined Tank



Glass Lined Agitator



Glass Lined Flanged Pipes and Fitting

#### Glass Lined Products:

- Glass Lined Reactors
- Glass Lined Storage Tanks
- Glass Lined Heat Exchangers
- Glass Lined Columns
- Glass Lined Pipes & Fittings
- Glass Lined Accessories
- Glass Lined Valves

#### Fluoropolymer Lined Products:

- PTFE Lining
- PFA Lining
- FEP Lining
- ECTFE Lining



### Products / Services:



Glass Lined Heat Treatment



Glass Lined Metal Fabrication



Glass Lined Metal Fabrication



Azarjam Factory

Tel: +98 21 66912435 +98 21 66925138  
Fax: +98 21 66918199  
Email: info@azarj.ir  
Web: www.azarj.ir  
Address: No 2, Khajoo Alley, 1th Kowsar Street, Sattarkhan Street,  
Tohid Sq. Tehran - IRAN

## Tasha Manufacturing Co.

Founded date: 1980

Office & workshop area: 185,500 m<sup>2</sup>

Number of Staff: 700

Design and manufacturing of Heavy Equipment,  
such as Towers, Pressure Vessels, Reactors, De salters, Separators, Flares,  
Heat Exchangers, Air Coolers, Heaters, Boilers and HRSGs.



Products / Services:



South Azadegan Desalters



Marjan Petrochemical Company Reactor



Lavan Project Column



Marjan Petrochemical Company Vertical Shell & Tube  
Heat Exchanger



South Pars Flare Package



Bushehr Petrochemical Company convection section

Products / Services:



Fire Heater  
Reboiler Heater



Harp fabrication Shop



Marjan Methanol Plant  
Auto Thermal Reformer (ATR)



HRSG for Bid Boland II Project



Reformer



Web: [www.tasha-co.com](http://www.tasha-co.com)

Address Head Quarter: 6th Fl. No. 31,  
West Maryam St. Fayazi (Fereshteh) St.  
Valie Asr Ave. Tehran, IRAN  
PO Box: 1969943676  
Tel: +98 21 22660898  
Fax: +98 21 22660898 (Ext . 2212)

Address Tasha workshop 1: No. 20, 5th St.,  
Zeitoun Industrial Zone, Ahwaz, IRAN  
PO Box: 6165759803  
Tel: +98 613 2288001-10  
Fax: +98 613 2289303

E-mail: [sales@tasha-co.com](mailto:sales@tasha-co.com)

Address Tasha workshop 2(main Factory):  
5<sup>th</sup> Km.Ahwaz. Bandar Imam Road, IRAN  
PO Box: 6177861198  
Tel: +98 613 228801-10  
Fax: +98 613 2289303

Address Tasha workshop 3(HRSG Shop):  
Esteghlal St., Industrial Zone 3 , Steel Mill  
Junction, Ahwaz, IRAN  
PO Box: 6177863439  
Tel: +98 613 2288001-10  
Fax: +98 613 2289303

## Tavan Mehvar azin sanat

Founded date: 2011 / 04 / 9  
Office & workshop area: 2000 m2  
Number of Staff: 25



### Products / Services:



Design and production of composite drive shaft  
Esfahan's Mobarakeh Steel company



Design and manufacture of composite fan blade  
Razi petrochemical co

### Products / Services:



Manufacturing of all kinds of metal and composite shim  
Shazand power plant Co.



Designed and manufactured a variety of metal couplings  
Abadan refinery

Tel: +98 7137744257  
Fax: +98 21 89788744  
E-mail: tavanmehvar778@gmail.com  
Web: www.tavanmehvar.ir  
Address: No17. 307ST. south Pazhoesh Bv. Industrial Township of SHIRAZ .  
IRAN



## Taghtiran Kashan Co.

Founded date: 1990  
Office & workshop area: 30 m2  
Number of Staff: 110



### Products / Services:



Owner: Ilam petro.  
Buyer: Eied  
Project: Sulfur Removal Unit



main business activitie:  
design and manufactur of fixed mechanical  
equipments & procurement of raw material



### Products / Services:



Owner: Bushehr Petrochemical Company (BUPC)  
Buyer: Parsian Sazeh Iranian  
Project: Busheher Metanol Plant

Office of Address: Flat 5, No.3, 2 Nd Street, Asad-Abadi Ave. Tehran, Iran  
Tel: +98 21 88969469 +98 21 88968619  
Fax: +98 21 88969469 (6) +98 21 88968619 (6)  
Factory of Address: Km 44 Of Kashan-Delijan Road. Mashad-e-Ardehal, Iran  
Tel: +98 86 44465185  
Fax: +98 86 44465111  
E-mail: office@taghtiran.ir  
Web: www.taghtiran.com

## Turbinedar

Founded date: 1981 / 09 / 29  
Office & workshop area: 16,500 m2  
Number of Staff: 80



### Products / Services:



Filters:  
platefilterpress, beltfilterpress, Vacuumdiskfilter, Vacuum  
drum filter, Vacuum belt filter, Candle filter, Screw press



Centrifugal:  
Decanter Centrifugal, Pusher Centrifugal, Batch Centrifugal,  
Continous Centrifugal, Peeler Centrifugal, Oil Separator



Heat exchange system:  
Crystallizer, Distillation Column, Evaporator, Dryer,  
Heat exchanger

### Products / Services:



Sedimentation filter:  
Lamella, Thickener



Shredder

Tel: +98 21 88788867 - 9  
Fax: +98 21 88782339  
E-mail: [info@turbinedar.com](mailto:info@turbinedar.com)  
Web: [www.turbinedar.com](http://www.turbinedar.com)  
Address: Apt. 7 No. 90 Sattari Blvd, Africa Ave,  
Tehran. Iran

## Yekta Tahviah Arvand IND

Founded date: 1995 / 11 / 23  
Office & workshop area: 50,000 m2  
Number of Staff: 250



### Products / Services:



Product Line



Air Handling unit  
3200-68000 m3/hr.



Air cooled Rooftop Packaged Unit  
14-100 kW ~ 4 to 30 TR

### Products / Services:



NASIM Fan Coil Floor and Ceiling Mounted  
300-800 CFM



Unit Heater  
1120 - 5200 kcal/hr



Water Cooled Condenser with DX evaporator  
128-2007 kW ~ 36-570 TR



Fin and Tube condenser with DX evaporator  
97-1918 kW ~ 28-546 TR (up to 52 C ambient temperatures)



Microchannel Condenser with DX evaporator  
100-1727 kW ~ 28-490 TR (up to 52 C ambient temperatures)

Tel: +98 21 51041000  
Fax: +98 21 51041119  
E-mail: [Marketing@arvandcorp.com](mailto:Marketing@arvandcorp.com)  
Web: [www.arvandcorp.com](http://www.arvandcorp.com)  
Address: NO 101 of TK part, esteghlal BIV,  
Shams abad Industrial Estate,  
Tehran - Iran



Fin and Tube condenser with flooded evaporator  
93-1376 kW ~ 27-391 TR (up to 52 C ambient temperatures)



## Glossary



## Glossary

CLASSIFICATION	PRODUCTS / SERVICES	NAME OF COMPANY	PAGE No.
Accessories	metallic and nonmetallic accessories	Ebdaagaran Padide	42-43
	bearing	Fars Afzar Kimiya Co.	60-61
	Handrail and ladder and other accessories	Petro Foolad Jahan Co.	136-137
	Manufacturer and supplier of all Metallic and Non metallic accessories	Rad Iran MFG Co.	152-153
Agitator	Design and Manufacturing Refinery and Petrochemical Components:-Industrial Agitators -Catalyst Charging (metering) Cylinder -Flow Meter (Nozzle) -Spare Parts	Arvin Sanat Apadana Co.	22-23
	Glass line agitator	Shimi Azarjam	170-171
Boiler	Water tube boiler	Azarab Industries Co.	28-29
	Hot Water Boiler	Daboo Sanat	36-37
	CHP Waste Gas boiler	Daboo Sanat	36-37
	Steam Boiler	Daboo Sanat	36-37
	Water tube steam boiler	Farayand Bokhar	56-57
	Heat recovery boiler (HRSG)	Farayand Bokhar	56-57
	Waste heat boilers	Farayand Bokhar	56-57
	Water tube boiler / HRSG	Fateh Sanat Kimia	62-63
	Waste heat boiler	Fateh Sanat Kimia	62-63
	Steam water boilers	Garma Gostar	66-67
	Hot water fire tube	Garma Gostar	66-67
	Water Tube and Fire Tube Boiler	Jahankar Esfahan	78-79
	Fire tube steam boilers and hot water boilers	Machine Sazi Arak Knowledge Base company	94-95
	Package / Industrial boiler	Mapna Boiler & Equipment Engineering and Manufacturing	102-103
	Conventional boiler	Mapna Boiler & Equipment Engineering and Manufacturing	102-103
	CHP Boiler	Mapna Boiler & Equipment Engineering and Manufacturing	102-103
	Domestic Hot Water, Boiler & Other Boiler Room Accessories	Packman	120-121
	Three Pass Hot Water Boiler	Packman	120-121

## Glossary

CLASSIFICATION	PRODUCTS / SERVICES	NAME OF COMPANY	PAGE No.
Boiler	Vertical Steam Boiler	Packman	120-121
	Condensing Boiler	Packman	120-121
	Domestic Hot Water, Boiler & Other Boiler Room Accessories	Packman	120-121
	Three pass wet back steam boiler	Pakfanbokhar	122-123
	Three pass dry back steam boiler	Pakfanbokhar	122-123
	Vertical steam boiler	Pakfanbokhar	122-123
	Three pass wet back hot water boiler	Pakfanbokhar	122-123
	Three pass dry back hot water boiler	Pakfanbokhar	122-123
	Reverse flame hot water boiler	Pakfanbokhar	122-123
	Firebox hot water boiler	Pakfanbokhar	122-123
	Oil heater boiler	Pakfanbokhar	122-123
	Reboiler Heater	Tasha Manufacturing Co.	172-173
	Heat recovery boiler (HRSG)	Tasha Manufacturing Co.	172-173
Burner	Automatic Coal Burner	Daboo Sanat	36-37
	Burn pit systems	Kimiagaran Sanat Pars	84-85
	Gas burner	Mashal Kaveh	108-109
	Gas-oil burner	Mashal Kaveh	108-109
Centrifuge	Centrifugal: Decanter Centrifugal, Pusher Centrifugal, Batch Centrifugal, Continuous Centrifugal, Peeler Centrifugal, Oil Separator	Turbinedar	178-179
Chemical Package	Chemical injection package	Chamman Engineering and Fabrication	34-35
	Design, manufacturing and installation of chemical package	Industrial Pioneers Faraynd	72-73
	Sulfur recovery plant	Interlock Co.	74-75
	Chemical Injection Package	Mahdin Industrial Company	96-97
	Process package and skids	Masnouat Felezi Sangin	110-111
	Chemical Injection Package	Production Picture Of Iran	146-147
	Installation of Sulfur Solidification Unit (SSU) of Gasoil Refinery	Sabz Ashian Apadana Eng	158-159
	Sulfur Removal Unit	Taghtiran Kashan Co.	176-177
Coating	Cladding in wellhead equipment Cladding in Pressure Vessels, Towers, Heat Exchangers, ... Cladding in Pipeline and Piping Systems Cladding in all types of Flange and Fitting Production and Supplying of Welding Consumable	Aliaj Joosh Aria	16-17

## Glossary

CLASSIFICATION	PRODUCTS / SERVICES	NAME OF COMPANY	PAGE No.
Coating	PTFE Bellows	Arya Seal Part	24-25
	Pipe internal FBE coating	Interlock Co.	74-75
	Bumper painting plant	Interlock Co.	74-75
	External pipe coating plant	Interlock Co.	74-75
	Corrosion repair and protection systems	Klevers Aryana	86-87
	Manufacture of galvanized coating lines	Machine Ajza Co.	90-91
	External anti corrosion pipe coatings	Mahshahr Pipe Protection Co.	98-99
	Internal pipe coatings	Mahshahr Pipe Protection Co.	98-99
	High Temperature & Thermal Insulation Coating	Mahshahr Pipe Protection Co.	98-99
	Offshore Coating	Mahshahr Pipe Protection Co.	98-99
	Custom Coating of Non Turbular Products	Mahshahr Pipe Protection Co.	98-99
	On Site Field Joint Coating and Rehabilitation	Mahshahr Pipe Protection Co.	98-99
	Compelet paint shop	Niroumoharekeh Machine Tools Co.	116-117
	Cladding of Equipment	Petrochemical Industries Design Equipment & Parts Manufacture Company (PIDEMCO)	140-141
	External anti corrosion pipe coatings	Salafchegan Pipe and Protection Co.	162-163
	Internal pipe coatings	Salafchegan Pipe and Protection Co.	162-163
	High Temperature & Thermal Insulation Coating	Salafchegan Pipe and Protection Co.	162-163
	Custom Coating of Non Turbular Products	Salafchegan Pipe and Protection Co.	162-163
	On Site Field Joint Coating and Rehabilitation	Salafchegan Pipe and Protection Co.	162-163
	Compressor	Flouropolymer lined products	Shimi Azarjam
glass lined products		Shimi Azarjam	170-171
Centrifugal compressor		Mangan Manufacturing Company	100-101
Air & Gas compressor(liquid ring, screw compressor, centrifugal compressor)		Pars Vacume Industries	128-129
Compressor	Design and Manufacturing engineered vacume compressor system	Pars Vacume Industries	128-129
	Centrifugal compressor	TUGA	106-107

## Glossary

CLASSIFICATION	PRODUCTS / SERVICES	NAME OF COMPANY	PAGE No.	
Condenser	Surface condenser	Fateh Sanat Kimia	62-63	
	Water cooled condenser	Yekta Tahviah Arvand Ind	180-181	
	Fin and tube condenser	Yekta Tahviah Arvand Ind	180-181	
	microchanel condenser	Yekta Tahviah Arvand Ind	180-181	
Connection	Belows	Arta Sanat Arsen	20-21	
	Belows valve	Farab	50-51	
	Expansion joints, Spring joints based on u type & belt type method	Klevers Aryana	86-87	
	Flange	Machine Sazi Arak Knowledge Base company	94-95	
	Magnetic coupling	Pars Sealing Systems Company(Burgman Pars)	126-127	
	Expansion joints (Ruubber, Metal, FabbriC)	Pars Sealing Systems Company(Burgman Pars)	126-127	
	Industrial Gasket Fabrication	Petrochemical Industries Design Equipment & Parts Manufacture Company (PIDEMCO)	140-141	
	glaas lined flanged pipes and fitting	Shimi Azarjam	170-171	
	Manufacturing all kind of metal and composite shim	Tavan Mehvar Azin Sanat	174-175	
	Design and manufacture a variety of metal coupling	Tavan Mehvar Azin Sanat	174-175	
	Conveyor	Heavy industrial Fan -Heavy Industrial Base Frames -Conveyor systems	Arvin Sanat Apadana Co.	22-23
		Material handling systems	Esfahan Machinery Manufacturing Company	44-45
		Belt conveyor	Fakoor Meghnatis Espadana	48-49
Bucket conveyors		Farineh Machine	58-59	
Hoppers		Farineh Machine	58-59	
Material Handling system		Foolad Paya Engineering Co.	64-65	
Screw conveyors		Hava Filter	68-69	
manufacture of conveying systems		Machine Ajza Co.	90-91	
manufacture of cement production line belt conveyors		Machine Ajza Co.	90-91	
Transtainer		Mangan Manufacturing Company	100-101	

## Glossary

CLASSIFICATION	PRODUCTS / SERVICES	NAME OF COMPANY	PAGE No.
Conveyor	Material handling systems	Niroumoharekeh Machine Tools Co.	116-117
Cooler/Heater	Air cooled heat condenser	Aban Air Cooler	12-13
	indirect cooling	Aban Air Cooler	12-13
	Water refrigeration package	Aban Air Cooler	12-13
	Air cooled condenser (ACC)	Aban innovative Technologies group Co.	14-15
	Heaters	Azarab Industries Co.	28-29
	Airconditioning, air movement and filtration	Centigrade Ind.Inc	32-33
	FOG system cooling	Centigrade Ind.Inc	32-33
	Direct fire heater	Chamman Engineering and Fabrication	34-35
	Hot Oil Heater	Daboo Sanat	36-37
	Fancoil balancing unit	Farab	50-51
	Fired heaters	Farayand Bokhar	56-57
	Super heater	Garma Gostar	66-67
	Air cooler	Kaveh Mobadel	80-81
	Fired heaters	Kimiagaran Sanat Pars	84-85
	Direct fire heater	Machine Sazi Arak Knowledge Base company	94-95
	construction of evaporation cooling system for gas turbin inlet air	Machine Ajza Co.	90-91
	Equipment of hot section	Mapna STS Co.	104-105
	ACC Dry cooling system	Mapna STS Co.	104-105
	Direct fired heater	Masnouat Felezi Sangin	110-111
	Indirect fired heater	Masnouat Felezi Sangin	110-111
	Air cooled chiller	Omran Tahviah Co.	118-119
	Modullar package air conditioners	Omran Tahviah Co.	118-119
	Hygienic air handling unit	Omran Tahviah Co.	118-119
	Air washer section	Omran Tahviah Co.	118-119
	FRP Cooling tower	Omran Tahviah Co.	118-119
	Dust proof cooling tower	Omran Tahviah Co.	118-119
	Thermal Oil Heater	Packman	120-121

## Glossary

CLASSIFICATION	PRODUCTS / SERVICES	NAME OF COMPANY	PAGE No.	
Cooler/Heater	conveciton section	Tasha Manufacturing Co.	172-173	
	Fire Heater	Tasha Manufacturing Co.	172-173	
	Air cooled rooftop package	Yekta Tahviah Arvand Ind	180-181	
	Fancoil floor and ceiling mounted	Yekta Tahviah Arvand Ind	180-181	
	Unit heater	Yekta Tahviah Arvand Ind	180-181	
Deaerator	Deaerators	Farayand Bokhar	56-57	
	Deaerators	Garma Gostar	66-67	
	Deaerator (steam, vacume)	Mahdin Inndustrial Company	96-97	
	Deaerator	Mapna Boiler & Equipment Engineering and Manufacturing	102-103	
	Deaerator	Masnouat Felezi Sangin	110-111	
	Deaerator	Pakfanbokhar	122-123	
	Engineering and Manufacturing of Packages: Deaerator	Pantan	124-125	
Desalter	Thermal Water Desalination	Daboo Sanat	36-37	
	Desalters	Farayand Bokhar	56-57	
	Manufacturing salt purification plant	Industrial Pioneers Faraynd	72-73	
	Sea water desalination system	Mapna Boiler & Equipment Engineering and Manufacturing	102-103	
	Thermal desalination plant	Mapna STS Co.	104-105	
	Electrostatic AC/DC desalter	Masnouat Felezi Sangin	110-111	
	Desalter	Paysaz Co.	134-135	
	Desalting Package	Production Picture Of Iran	146-147	
	Oil Desalting Package	Production Picture Of Iran	146-147	
	Desalters	Tasha Manufacturing Co.	172-173	
	Drum/Tank/Vessel	Pressure vessels	Aban Air Cooler	12-13
		Tank, Vessel and Drums	Azarab Industries Co.	28-29
		Nitrogen storage package	Chamman Engineering and Fabrication	34-35
Storage Tank		Esfahan Machinery Manufacturing Company	44-45	

## Glossary

CLASSIFICATION	PRODUCTS / SERVICES	NAME OF COMPANY	PAGE No.
Drum/Tank/Vessel	Pressure vessel	Esfahan Machinery Manufacturing Company	44-45
	SRJ	Farayand Bokhar	56-57
	Pressure vessels	Farayand Bokhar	56-57
	Pressure vessel / tower / column	Fateh Sanat Kimia	62-63
	Pressure vessels (Column, Tower, K.O, Drum, Reactor)	Foolad Paya Engineering Co.	64-65
	Storage tank, Atmospheric vessels	Foolad Paya Engineering Co.	64-65
	Pressure vessels, vertical & horizontal	Garma Gostar	66-67
	Design and manufacturing of equipment such as pressure vessels, centrifuge, dryer &...	Industrial Pioneers Faraynd	72-73
	Gas storage plant	Interlock Co.	74-75
	Storage and Vessels Tank	Jahankar Esfahan	76-77
	Atmospheric storage tank	Kaveh Mobadel	80-81
	Pressure vessels	Kaveh Mobadel	80-81
	Pressure vessel	Mahdin Inndustrial Company	96-97
	Drum	Mahdin Inndustrial Company	96-97
	Storage tank (double wall, cryogenic)	Mahdin Inndustrial Company	96-97
	Pressure vessel & Storage tank	Mapna Boiler & Equipment Engineering and Manufacturing	102-103
	Pressure vessel / tower and reactor	Masnouat Felezi Sangin	110-111
	Spherical and double wall tank	Masnouat Felezi Sangin	110-111
	Fix and Floating roof storage tank	Masnouat Felezi Sangin	110-111
	Horizontal tank heater	Pakfanbokhar	122-123
	Small Pressure Vessel and Heat Exchanger Manufacturing	Pantan	124-125
	Gallon Tank	Paya Sanat Ahwaz	132-133
	Acid Tanker	Paya Sanat Ahwaz	132-133
	Solution Tank	Paya Sanat Ahwaz	132-133
	BBL Acid Tank	Paya Sanat Ahwaz	132-133
	Storage Tank	Paysaz Co.	134-135

## Glossary

CLASSIFICATION	PRODUCTS / SERVICES	NAME OF COMPANY	PAGE No.	
Drum/Tank/Vessel	Drum	Paysaz Co.	134-135	
	Storage tank	Petro Foolad Jahan Co.	136-137	
	Construction of floating roof tank	Qeshm Offshore Freeport and Industries	150-151	
	EPC Constrution of portable water storage tank	Qeshm Offshore Freeport and Industries	150-151	
	PTFE lined tank	Shimi Azarjam	170-171	
Duct	Silo / Duct	Esfahan Machinery Manufacturing Company	44-45	
	Stack & Duct	Paysaz Co.	134-135	
	Air handling unit	Yekta Tahviah Arvand Ind	180-181	
Elastomer	Packing	Farapishtaz Hoonam Rubber Industries	54-55	
	Rubber profiles	Farapishtaz Hoonam Rubber Industries	54-55	
	O Ring	Farapishtaz Hoonam Rubber Industries	54-55	
	Gasket	Farapishtaz Hoonam Rubber Industries	54-55	
	Diaphragm	Farapishtaz Hoonam Rubber Industries	54-55	
	Blader Rubber	Farapishtaz Hoonam Rubber Industries	54-55	
	Rubber - Metal combined parts	Farapishtaz Hoonam Rubber Industries	54-55	
	Rubber flooring	Farapishtaz Hoonam Rubber Industries	54-55	
	Flexible houses (Rubber, metel)	Pars Sealing Systems Company (Burgman Pars)	126-127	
	Gasket (espiral wound)	Pars Sealing Systems Company (Burgman Pars)	126-127	
	Packing	Pars Sealing Systems Company (Burgman Pars)	126-127	
	Fan	Heavy industrial Fan -Heavy Industrial Base Frames -Conveyor systems	Arvin Sanat Apadana Co.	22-23
		Air distribution package	Centigrade Ind.Inc	32-33
		Fans (3000 m <sup>3</sup> /h -200000 m <sup>3</sup> /h)	Hava Filter	68-69
Axial fan		Mangan Manufacturing Company	100-101	
Design and manufacture of composite fan blade		Tavan Mehvar Azin Sanat	174-175	



## Glossary

CLASSIFICATION	PRODUCTS / SERVICES	NAME OF COMPANY	PAGE No.
Filter	Precipitator and dust filtration	Centigrade Ind.Inc	32-33
	Design and Manufacturing of filter systems	Deylaman Filter	40-41
	Design and Manufacturing of industrial filters used in Oil and Gas ,...	Deylaman Filter	40-41
	Dedusting systems	Esfahan Machinery Manufacturing Company	44-45
	Strainer	Euroslot Pars	46-47
	Sannd filters internal	Euroslot Pars	46-47
	Cartridge filter up to 2 micrins	Euroslot Pars	46-47
	Well screen	Euroslot Pars	46-47
	Strainers	Garma Gostar	66-67
	Bag filters	Hava Filter	68-69
	Bag houses (pulse & reverse air)	Hava Filter	68-69
	Packed towers	Hava Filter	68-69
	Gas filter	Kaveh Mobadel	80-81
	Construction of gas turbine pre filter unit	Machine Ajza Co.	90-91
	Sand filter	Pakfanbokhar	122-123
	Air filter pressure regulator 0-1000 PSI	Rasta Group	154-155
	Hepa & Ulpa	Sanat Yaran Co.	166-167
	Varicell	Sanat Yaran Co.	166-167
	Bag filters	Sanat Yaran Co.	166-167
	prefilters	Sanat Yaran Co.	166-167
	Rollmatic	Sanat Yaran Co.	166-167
	Carbon active	Sanat Yaran Co.	166-167
	Desalination Sand-Filter Tank	Sazvar Sazeh Azarestan	168-169
Filters: plate filter press, belt filter press, Vacuum disk filter, Vacuum drum filter, Vacuum belt filter, Candle filter, Screw press	Turbinedar	178-179	
Sedimentation filter	Turbinedar	178-179	
Firefight	Tunnel ventilation, firefighting and automation	Centigrade Ind.Inc	32-33
	Fire fighting container package	Machin Rood Pars Arak	92-93

## Glossary

CLASSIFICATION	PRODUCTS / SERVICES	NAME OF COMPANY	PAGE No.
Firefight	Airport crash tender fire engine	Sanat Karan Berym Co.	164-165
	Dry chemical powder vehicle	Sanat Karan Berym Co.	164-165
	Electrical hazards operation vehicle	Sanat Karan Berym Co.	164-165
	Fire engines	Sanat Karan Berym Co.	164-165
	Relief and rescue vehicle	Sanat Karan Berym Co.	164-165
	Urban and rapid response fire vehicle	Sanat Karan Berym Co.	164-165
Fixed Equipment	design and manufactur of fixed mechanical equipments & procurement of raw material	Taghtiran Kashan Co.	176-177
Flare	Flare	Azarab Industries Co.	28-29
	Flare and burn pit	Fateh Sanat Kimia	62-63
	Flare	Foolad Paya Engineering Co.	64-65
	Flare system	Kimiagaran Sanat Pars	84-85
	Flare stack and incinerator	Masnouat Felezi Sangin	110-111
	Flare Equipment	Poolad Varzan-E- Kimia Co.	144-145
	Flare Package	Production Picture Of Iran	146-147
	Flare Packages	Tasha Manufacturing Co.	172-173
	Furnace	Regeneration gas loop dryer	Chamman Engineering and Fabrication
Box Annealing Furnace		Daboo Sanat	36-37
Heat Treatment Furnace		Daboo Sanat	36-37
Hydrogen annealing furnaces		Farayand Bokhar	56-57
Furnace/ Combustion system/ incinerator package		Fateh Sanat Kimia	62-63
Heat racovery system, Furnace		Foolad Paya Engineering Co.	64-65
H.P Type incinerators rang 150-1000 Kg/h		Machine Sazi Arak Knowledge Base company	94-95
Generator		Heat recovery steam generator	Azarab Industries Co.
	Heat recovery steam generator	Mapna Boiler & Equipment Engineering and Manufacturing	102-103
Heat Exchanger	Air cooled heat exchanger	Aban Air Cooler	12-13
	Helical shell and tube heat exchanger	Aban Air Cooler	12-13
	Fin tubes	Aban Air Cooler	12-13

## Glossary

CLASSIFICATION	PRODUCTS / SERVICES	NAME OF COMPANY	PAGE No.
Heat Exchanger	Exchangers, Air coolers	Azarab Industries Co.	28-29
	Heat Exchanger Shell & Tube	Daboo Sanat	36-37
	Air Cooler	Daboo Sanat	36-37
	Finned Tube	Damafin Thermal Technology	38-39
	Shell and Tube Heat Exchanger	Damafin Thermal Technology	38-39
	Heat exchangrs	Esfahan Machinery Manufacturing Company	44-45
	Shell & tube exchanger	Fateh Sanat Kimia	62-63
	Air cooled exchanger	Fateh Sanat Kimia	62-63
	Plate heat exchanger	Fateh Sanat Kimia	62-63
	Transfer line exchanger	Fateh Sanat Kimia	62-63
	Heat exchanger, Tube bundle, Air cooler	Foolad Paya Engineering Co.	64-65
	Shell and Tube heat exchanger	Kaveh Mobadel	80-81
	Heat exchanger	Mahdin Industrial Company	96-97
	Heat exchanger	Mapna Boiler & Equipment Engineering and Manufacturing	102-103
	Shell & tube heat exchanger	Masnouat Felezi Sangin	110-111
	Air handling unit and heat exchanger	Niroumoharekeh Machine Tools Co.	116-117
	Shell & Tube Heat Exchangers	Petrochemical Industries Design Equipment & Parts Manufacture Company (PIDEMCO)	140-141
	Transfer Line Exchanger	Petrochemical Industries Design Equipment & Parts Manufacture Company (PIDEMCO)	140-141
	Converter & Heat Exchangers of Acid Plants	Petrochemical Industries Design Equipment & Parts Manufacture Company (PIDEMCO)	140-141
	Converter & Heat Exchangers of Acid Plants	Petrochemical Industries Design Equipment & Parts Manufacture Company (PIDEMCO)	140-141
Heat Exchanger (Shell and Tube, Plate, Air Cooled)	Poolad Varzan-E- Kimia Co.	144-145	

## Glossary

CLASSIFICATION	PRODUCTS / SERVICES	NAME OF COMPANY	PAGE No.
Heat Exchanger	Plate & Frame	Production Picture Of Iran	146-147
	Shell & Tube Heat Exchanger	Tasha Manufacturing Co.	172-173
	Heat exchange system: Crystallizer, Distillation Column, Evaporator, Dryer, Heat exchanger	Turbinedar	178-179
Insulation	Rockwool insulation	Aria Rockwool Company	18-19
	Rock Wool Blanket Insulation	Aria Rockwool Company	18-19
	Rock wool Pipe insulation	Aria Rockwool Company	18-19
	Rockwool panel insulation	Aria Rockwool Company	18-19
	PIR cold insulation	Aria Rockwool Company	18-19
	PIR preformed insulation	Aria Rockwool Company	18-19
	Injection foam insulation	Aria Rockwool Company	18-19
	PIR Spry insulation	Aria Rockwool Company	18-19
	Mastic	Aria Rockwool Company	18-19
	Nosie Protection systems -Enclosure systems	Arvin Sanat Apadana Co.	22-23
	Design and Manufacturing: -Industrial Silencers -Fan Silencers -Drain Silencers -Vent Silencers -Safety valve Silencers	Arvin Sanat Apadana Co.	22-23
	Damper valve, louvers and silencer	Centigrade Ind.Inc	32-33
	Inner Cover	Daboo Sanat	36-37
	Aluminium jacketing Insulation	Ebdaagaran Padide	42-43
	Polysurlyn and Polyethylene films	Ebdaagaran Padide	42-43
	Silencer	Euroslot Pars	46-47
	Silencers	Farayand Bokhar	56-57
	Aluminum Jacketing & Accessories	Jahan Ayegh Pars	76-77
	Ceramic Fiber	Jahan Ayegh Pars	76-77
	Foam Glass	Jahan Ayegh Pars	76-77
	Polyurethane and Polyisocyanurate	Jahan Ayegh Pars	76-77
	Removable Jacketing& Pillow Insulation	Jahan Ayegh Pars	76-77
Rock Wool	Jahan Ayegh Pars	76-77	
Versatile insulation material for all temprature rang from -128°C to +1260°C, Good chemical resistanc at high temprature	Klevers Aryana	86-87	

## Glossary

CLASSIFICATION	PRODUCTS / SERVICES	NAME OF COMPANY	PAGE No.
Insulation	Clading insulation for gas / steam turbin Ancillary systems	Klevers Aryana	86-87
	Redesign and modernmized old insulation system to high quality jacket	Klevers Aryana	86-87
	Thermal and auoustical insulation for valves, flanges, ...	Klevers Aryana	86-87
	Insulation of gas turbine, Tharmal acoustic jacket	Klevers Aryana	86-87
	Passive fire protection jacket to protect assets, ESDV, valve, in challenging environment	Klevers Aryana	86-87
	Construction of gas turbine enclosure unit	Machine Ajza Co.	90-91
	construction of acoustic enclosure unit for industrial turbo compressor	Machine Ajza Co.	90-91
	Manufacturer different types of Polysurlyn and Polyethylens film	Rad Iran MFG Co.	152-153
Internals	Reactors internal	Euroslot Pars	46-47
	Vessels / Dryers internal	Euroslot Pars	46-47
	Collumns internal	Euroslot Pars	46-47
	Special vessels internal	Euroslot Pars	46-47
	Process Vessel, Drums (Separators) and Reactor Internals	Pantan	124-125
	Construction and supply of Tower & Reactor Internal Parts and Accessories	Petrochemical Industries Design Equipment & Parts Manufacture Company (PIDEMCO)	140-141
	Construction and supply of Tower & Reactor Internal Parts and Accessories	Petrochemical Industries Design Equipment & Parts Manufacture Company (PIDEMCO)	140-141
Jack/Crane	Special equipments such as stackers and reclaimers	Esfahan Machinery Manufacturing Company	44-45
	Loading arms	Farayand Bokhar	56-57
	Bucket elevators	Farineh Machine	58-59
	Wagon loading stations	Farineh Machine	58-59
	Reclaimers	Farineh Machine	58-59
	Palletizing and Shrink	Farineh Machine	58-59
	Skied mounted package	Fateh Sanat Kimia	62-63
	Ship unloader	Machine Sazi Arak Knowledge Base company	94-95

## Glossary

CLASSIFICATION	PRODUCTS / SERVICES	NAME OF COMPANY	PAGE No.
Jack/Crane	Truck mount platform	Machine Ajza Co.	90-91
	Double boom crane	Mangan Manufacturing Company	100-101
	Explosion proof crane	Mangan Manufacturing Company	100-101
	Harbor mobile crane	Mangan Manufacturing Company	100-101
	Offshore crane	Mangan Manufacturing Company	100-101
	Stacker & Raclaimer	Mangan Manufacturing Company	100-101
	Unloader	Mangan Manufacturing Company	100-101
	Hydraulic Power Pack & Manifold Blocks, Hydraulic & Pneumatic Cylinders	Pars Zagros Heavy Machinery Co.	130-131
	Construction of marine pedstal - crane	Qeshm Offshore Freeport and Industries	150-151
	Shredder	Turbinedar	178-179
Machinery	Baging machine	Farineh Machine	58-59
	Big bag filling machine	Farineh Machine	58-59
	Parts, Components and equipment for production lines	Fars Afzar Kimiya Co.	60-61
	AAC Production plant	Industrial Pioneers Faraynd	72-73
	Crystal melamine plante	Interlock Co.	74-75
	Asphalt plant	Machine Roll	88-89
	Slitting Line	Pars Zagros Heavy Machinery Co.	130-131
	Machinery Service	Petrochemical Industries Design Equipment & Parts Manufacture Company (PIDEMCO)	140-141
	Machinery Service	Petrochemical Industries Design Equipment & Parts Manufacture Company (PIDEMCO)	140-141
	Tube Expanding Machine	Poolad Varzan-E- Kimia Co.	144-145
Mine	Floating	Fakoor Meghnatis Espadana	48-49
	Roller screen	Fakoor Meghnatis Espadana	48-49

## Glossary

CLASSIFICATION	PRODUCTS / SERVICES	NAME OF COMPANY	PAGE No.
Mine	Feeder	Fakoor Meghnatis Espadana	48-49
	Crusher	Fakoor Meghnatis Espadana	48-49
	Cement lining plant	Interlock Co.	74-75
	Jaw crushers	Machine Roll	88-89
	Vertical shaft impact crushers	Machine Roll	88-89
	Screens (two shaft & inclines)	Machine Roll	88-89
	Heavy duty vibration feeders	Machine Roll	88-89
Mixer	Static mixer	Euroslot Pars	46-47
	Engineering and Manufacturing of Packages: Static Mixer	Pantan	124-125
Other	Recuperator	Aban Air Cooler	12-13
	Supply System	Arta Sanat Arsen	20-21
	Refill Unit	Arta Sanat Arsen	20-21
	DESIGN & RETROFIT	Arya Seal Part	24-25
	JOURNAL BEARING	Arya Seal Part	24-25
	Shotblast	Asto Machine and Industrial Structure Manufacturing Co.	26-27
	BKA's lab	Behesht Kavir Aryana	30-31
	TEG Dehydrating package	Chamman Engineering and Fabrication	34-35
	Ejector packages	Farayand Bokhar	56-57
	Unmanned helicopter	Fars Afzar Kimiya Co.	60-61
	Medical parts: Nail, Plaque, Spin set, Cross-fit screw, Mesh, Burr hole, Burr Hole Covers, hole T-Plate, Chin plate, Orthopedic Implants	Fars Afzar Kimiya Co.	60-61
	General services	Foolad Paya Engineering Co.	64-65
	Economizer	Garma Gostar	66-67
	Design and establish of API plant	Industrial Pioneers Faraynd	72-73
	Design and installation of clean room	Industrial Pioneers Faraynd	72-73
	Process package	Mahdin Inndustrial Company	96-97

## Glossary

CLASSIFICATION	PRODUCTS / SERVICES	NAME OF COMPANY	PAGE No.
Other	De Oiling	Mapna Boiler & Equipment Engineering and Manufacturing	102-103
	Services: Erection & Comossioning- Inspection- Performance test- Mainteinance and repair- ...	Mapna Boiler & Equipment Engineering and Manufacturing	102-103
	Engineering services for performance improvement or capacity enhancement in in distillation and separation processes as Revamping	Pantan	124-125
	Engineering and Manufacturing of Packages: • Gas Sweetening • Gas Dehydration • Solvent Recovery • Cyclone	Pantan	124-125
	Installation and Installation supervision services	Pantan	124-125
	Glycol Dehydration Package	Production Picture Of Iran	146-147
	TEG Regeneration Package	Production Picture Of Iran	146-147
	Sadid oil and gas development / EPC in oil and gas sector	Sadid Inbustrial Group	160-161
	Falegh sanat company/ Industrial general contractor	Sadid Inbustrial Group	160-161
	HARP FABRICATION SHOP	Tasha Manufacturing Co.	172-173
	Pipe	BKA's Company (GRP,GRV,GRE pipes)	Behesht Kavir Aryana
GRV & GRVE pipe and flange		Behesht Kavir Aryana	30-31
Spiral pipe plant		Interlock Co.	74-75
Water and Gas Pipe, Piping And welding pipe		Jahankar Esfahan	78-79
Pipe line project		Machin Rood Pars Arak	92-93
ERW (Electric Resistance Welding) Steel Tube Mill		Pars Zagros Heavy Machinery Co.	130-131
Pipe End-Facing & Bevelling Machine		Pars Zagros Heavy Machinery Co.	130-131
Pipe Hydro-Testing Machine		Pars Zagros Heavy Machinery Co.	130-131
Pipe Threading Machine		Pars Zagros Heavy Machinery Co.	130-131
Construction, Installalation & Pre-Commission of AG/UG Piping and Mechanical Equipment and BOG Unit		Sabz Ashian Apadana Eng	158-159
Mahshahr pipe mill/longitudinal submerged arced Welding pipes		Sadid Inbustrial Group	160-161

## Glossary

CLASSIFICATION	PRODUCTS / SERVICES	NAME OF COMPANY	PAGE No.
Pipe	Sadid pipe and instrument company / Spiral type pipes up to 120 inches in diameter	Sadid Inbustrial Group	160-161
	Steel pipe for oil, gas and water transmission lines and structural pipes	Salafchegan Pipe and Protection Co.	162-163
Platform	construction of platforms, structures and handrails	Machine Ajza Co.	90-91
	Platform	Petro Foolad Jahan Co.	136-137
	Tasdid offshore and onshore development company/ Leading regional petroleum	Sadid Inbustrial Group	160-161
Power Plant	Combine cycle and steam power plant	Aban Air Cooler	12-13
	Hydraulic power plant and equipment	Azarab Industries Co.	28-29
	Dam and power plant	Machine Sazi Arak Knowledge Base company	94-95
	Equipment of thermal power plant	Mapna STS Co.	104-105
	CHP	Packman	120-121
	Farab company/ Terral power plant; oil, gas & petrochemical project	Sadid Inbustrial Group	160-161
Pump	Oil Pump (Triple Screw Pump)	Fars Afzar Kimiya Co.	60-61
	pumps parts, gears, Various types of PEEK, PTFE, Carbon Teflon, polyamide, plastic and ... Parts	Fars Afzar Kimiya Co.	60-61
	Pumps (CP, VSPI, VDL6, BB5, HG2, VS1, BS3, venus,...)	Heavy Duty Pump and Water Turbine Mfg Co.	70-71
	High speed centrifugal pump (single stage) OH6	Kavosh Sanat Toos	82-83
	High speed centrifugal pump (multi stage)	Kavosh Sanat Toos	82-83
	Pumps (BB3, BB5)	Machin Rood Pars Arak	92-93
	Pumps (OH2, OH6)	Machin Rood Pars Arak	92-93
	Pumps (VS4, VS6)	Machin Rood Pars Arak	92-93
	OH1-OH2 Pump (API 610)	Navid Sahand Pump Manufacturing Industries Co.	114-115
	VS1 Pump (API 610)	Navid Sahand Pump Manufacturing Industries Co.	114-115
	VS4 Pump (API 610)	Navid Sahand Pump Manufacturing Industries Co.	114-115
	BB1-BB4 pump	Navid Sahand Pump Manufacturing Industries Co.	114-115
	Slurry pump (Iso 5199)	Navid Sahand Pump Manufacturing Industries Co.	114-115
	Vacume pumps (liquid ring, screw vacume, rotary vane, rotary piston, vacume booster)	Pars Vacume Industries	128-129

## Glossary

CLASSIFICATION	PRODUCTS / SERVICES	NAME OF COMPANY	PAGE No.
Pump	Centrifugal pump for process	Pars Vacume Industries	128-129
	Pump Truck	Paya Sanat Ahwaz	132-133
	Centrifugal pump BB1 , BB3 , OH2	Petro Pump Engineering. Design and Manufacture	138-139
	Centrifugal hot oil pump	Petro Pump Engineering. Design and Manufacture	138-139
	Centrifugal slurry pump	Petro Pump Engineering. Design and Manufacture	138-139
	Reciprocating triplex plunger single acting pump	Petro Pump Engineering. Design and Manufacture	138-139
	Reciprocating double acting piston pump	Petro Pump Engineering. Design and Manufacture	138-139
	Petro fire pump	Petro Pump Engineering. Design and Manufacture	138-139
	Trash pump	Petro Pump Engineering. Design and Manufacture	138-139
	Special mobile sewage pump	Petro Pump Engineering. Design and Manufacture	138-139
	120 Bar process water	Pumpiran	148-149
	Boiler feed Pump	Pumpiran	148-149
	High delivery water transfer ppump	Pumpiran	148-149
	Crude oil trasfer pump (BB1, BB3)	Pumpiran	148-149
	Hot oil pump (OH2, OH3)	Pumpiran	148-149
	Voiling water pump (VS1)	Pumpiran	148-149
	High press process pump	Pumpiran	148-149
	Double suction horizontal/vertical pump	Pumpiran	148-149
	Submerged and sludge electro-pumps	Rased Sanat Toseae	156-157
	Pumping stations, water transfer channels or drainage channels	Rased Sanat Toseae	156-157
	Product & repair of different kinds of electro pumps	Rased Sanat Toseae	156-157
	Hydraulic test kind of pump and electro pump	Rased Sanat Toseae	156-157
	Pump and monitors	Sanat Karan Berym Co.	164-165
Trailer pump	Sanat Karan Berym Co.	164-165	
Reactor	Reactors	Azarab Industries Co.	28-29
	Chemical reactors	Garma Gostar	66-67

## Glossary

CLASSIFICATION	PRODUCTS / SERVICES	NAME OF COMPANY	PAGE No.
<b>Reactor</b>	Reactor	Machine Sazi Arak Knowledge Base company	94-95
	Reactor	Mahdin Inndustrial Company	96-97
	Pressure vessel/tower and reactor	Masnouat Felezi Sangin	110-111
	Hydrogenation Reactor	Petrochemical Industries Design Equipment & Parts Manufacture Company (PIDEMCO)	140-141
	Glass line reactors	Shimi Azarjam	170-171
	Reactor	Tasha Manufacturing Co.	172-173
	<b>Refinery</b>	Spent cuastic treatment package	Chamman Engineering and Fabrication
Bitumen plant		Interlock Co.	74-75
Multi cyclone scrubber		Masnouat Felezi Sangin	110-111
Mobile Oil Treatment (MOT)		Paya Sanat Ahwaz	132-133
Installation of Urea unit of 3rd Phase of the Pardis Petrochemical Company		Sabz Ashian Apadana Eng	158-159
Completion of Work, Pre-commission & Punch List Removing and Start Up Refinery		Sabz Ashian Apadana Eng	158-159
Implementation of Export Terminal of Petrochemical Company		Sabz Ashian Apadana Eng	158-159
<b>Reformer</b>	Reformer	Azarab Industries Co.	28-29
	Reformer	Chamman Engineering and Fabrication	34-35
	Reformer	Fateh Sanat Kimia	62-63
	Reformer	Foolad Paya Engineering Co.	64-65
	Auto Thermal Reformer	Tasha Manufacturing Co.	172-173
<b>Scrubber</b>	Ventyri air scrubbers	Hava Filter	68-69
	Scrubber	Paysaz Co.	134-135

## Glossary

CLASSIFICATION	PRODUCTS / SERVICES	NAME OF COMPANY	PAGE No.
<b>Seal</b>	Single Mechanical Seal	Arta Sanat Arsen	20-21
	Double Mechanical Seal	Arta Sanat Arsen	20-21
	Cartex Mechanical Seal	Arta Sanat Arsen	20-21
	Multi Spring Mechanical Seal	Arta Sanat Arsen	20-21
	Single Spring Mechanical Seal	Arta Sanat Arsen	20-21
	DGS Seal	Arya Seal Part	24-25
	Double Agitator Seal	Arya Seal Part	24-25
	Double Cartridge Seal	Arya Seal Part	24-25
	Mechanical seal	Pars Sealing Systems Company (Burgman Pars)	126-127
	Dry gas seal	Pars Sealing Systems Company (Burgman Pars)	126-127
	Mechanical seal supply system	Pars Sealing Systems Company(Burgman Pars)	126-127
	<b>Sensor</b>	Design and Manufacturing Refinery and Petrochemical Components: -IndustrialA gitators -Catalyst Charging (metering) Cylinder -Flow Metter (Nozzle) -Spare Parts	Arvin Sanat Apadana Co.
Different types of actuators, pumps and sensors		Fars Afzar Kimiya Co.	60-61
Tharmal analysis		Klevers Aryana	86-87
Continuous Emission Monitoring System/Flue Gas Monitoring System		Piramoons System Qeshm	142-143
Liquid Analyzers (pH, Conduct, DO, Chlorine, Turbidity)		Piramoons System Qeshm	142-143
Waste Water Analyzers		Piramoons System Qeshm	142-143
BTU Analyzers/ Wobbe Index Analyzers		Piramoons System Qeshm	142-143
Gas Chromatograph Analyzer		Piramoons System Qeshm	142-143
Special analyzers (tail Gas, Moisture)		Piramoons System Qeshm	142-143

## Glossary

CLASSIFICATION	PRODUCTS / SERVICES	NAME OF COMPANY	PAGE No.
Separator	Air separation unit	Azarab Industries Co.	28-29
	Design and Manufacturing of Separator, scrubber and Knock out Drumes	Deylaman Filter	40-41
	Two/ Three phase separator	Euroslot Pars	46-47
	Wet/Belt magnetic drum separator	Fakoor Meghnatis Espadana	48-49
	Separator, vertical & horizontal	Garma Gostar	66-67
	Separator	Kaveh Mobadel	80-81
	Two phase separator	Masnouat Felezi Sangin	110-111
	Engineering and Manufacturing of Packages: • Multiphase Separation • Gas Separation	Pantan	124-125
	Mobile Oil Separator (MOS)	Paya Sanat Ahwaz	132-133
	Separator	Paysaz Co.	134-135
Service	Service	Asto Machine and Industrial Structure Manufacturing Co.	26-27
Shafts / Motor / Gearbox	Hydromotor	Fars Afzar Kimiya Co.	60-61
	Shafts	Fars Afzar Kimiya Co.	60-61
	Planetary gearbox	Mangan Manufacturing Company	100-101
	Parallel flow regeneration shaft	Mapna STS Co.	104-105
	Vertical hallow shaft	Momtaz Pump	112-113
	Gearboxes	Pars Zagros Heavy Machinery Co.	130-131
	Design and product composite drive shaft	Tavan Mehvar Azin Sanat	174-175
Spare Parts	Design and Manufacturing Refinery and Petrochemical Components: -IndustrialA gitators -Catalyst Charging (metering) Cylinder -Flow Metter (Nozzle) -Spare Parts	Arvin Sanat Apadana Co.	22-23
	Metal Spare Partsdesign	Arya Seal Part	24-25
	spare parts	Fars Afzar Kimiya Co.	60-61
	Supply and Manufacturing of spare parts related to Process Vessel, Separators and Reactor Internals	Pantan	124-125
Steel	H Beam	Asto Machine and Industrial Structure Manufacturing Co.	26-27
	Casting	Machine Sazi Arak Knowledge Base company	94-95

## Glossary

CLASSIFICATION	PRODUCTS / SERVICES	NAME OF COMPANY	PAGE No.
Steel	manufacture of steel production lines cable trays and ladders	Machine Ajza Co.	90-91
	Steel Coil Inspection Lines	Pars Zagros Heavy Machinery Co.	130-131
	Steel Coil Packing Line	Pars Zagros Heavy Machinery Co.	130-131
	Continues Casting Machine	Pars Zagros Heavy Machinery Co.	130-131
	Gostaresh steel industry/ EPC, EPCF in steel and mine	Sadid Inbustrial Group	160-161
	Steel Structure	Asto Machine and Industrial Structure Manufacturing Co.	26-27
	Steel structure	Esfahan Machinery Manufacturing Company	44-45
Structure	Mechanical constructures contractor for oil, gas, petrochemical, steel, aluminum, cement , ...	Esfahan Machinery Manufacturing Company	44-45
	Designing-Prepare construction hydromechanical and electrical equipment	Faradid Mihan Engineering Company	52-53
	Industrial steel structure	Foolad Paya Engineering Co.	64-65
	Construction works	Foolad Paya Engineering Co.	64-65
	Steel Structure for Industrial and Building	Jahankar Esfahan	78-79
	Arch bridges	Machine Sazi Arak Knowledge Base company	94-95
	Steel strutures	Machine Sazi Arak Knowledge Base company	94-95
	Pipe rack	Petro Foolad Jahan Co.	136-137
	Guard rail	Petro Foolad Jahan Co.	136-137
	Grating	Petro Foolad Jahan Co.	136-137
	Bracket and hook	Petro Foolad Jahan Co.	136-137
	Bridge	Petro Foolad Jahan Co.	136-137
	Architectural & HVAC project	Qeshm Offshore Freeport and Industries	150-151
	Breakwater and wharf constrution	Qeshm Offshore Freeport and Industries	150-151
	Extension of air port	Qeshm Offshore Freeport and Industries	150-151
	Two panton jetty construction projects	Qeshm Offshore Freeport and Industries	150-151
	Connstruction of AG Piping, Civil, Steel Struture, Equipment	Sabz Ashian Apadana Eng	158-159

## Glossary

CLASSIFICATION	PRODUCTS / SERVICES	NAME OF COMPANY	PAGE No.
Structure	Construction Two Sets of Staff Resorts	Sabz Ashian Apadana Eng	158-159
	Fabrication and Installation of Steel Structure	Sabz Ashian Apadana Eng	158-159
	Fabrication of Steel Structures	Sazvar Sazeh Azarestan	168-169
Supply System	Supply System	Arya Seal Part	24-25
Tower/column	Columns	Azarab Industries Co.	28-29
	Pressure vessel / tower / column	Fateh Sanat Kimia	62-63
	Distillation towers	Garma Gostar	66-67
	Column	Kaveh Mobadel	80-81
	Tower	Mahdin Inndustrial Company	96-97
	Pig L/R column	Mahdin Inndustrial Company	96-97
	Heler-Dry cooling tower	Mapna STS Co.	104-105
	Pressure vessel / tower and reactor	Masnouat Felezi Sangin	110-111
	Tower	Paysaz Co.	134-135
	Huge Column	Paysaz Co.	134-135
	Isomax Tower Revamp	Petrochemical Industries Design Equipment & Parts Manufacture Company (PIDEMCO)	140-141
	Column	Tasha Manufacturing Co.	172-173
	Tube	steel tubes	Ebdaagaran Padide
Coiled Tubing Unit		Paya Sanat Ahwaz	132-133
Tubes (Spiral Tube, U-Tube, Fin Tube, Tube Bundle)		Poolad Varzan-E- Kimia Co.	144-145
Turbine	Turbin air intake cooling	Centigrade Ind.Inc	32-33
	Rolls-Royce and Solar turbines parts	Fars Afzar Kimiya Co.	60-61
	Turbine Parts and Blades	Fars Afzar Kimiya Co.	60-61
	Wind turbine tower	Mapna STS Co.	104-105
	Vertical turbine pump and motor	Momtaz Pump	112-113
	Saba niroo company / Wind turbine manufacturing and design	Sadid Inbndustrial Group	160-161
	Tavan bad company/ Wind farm developer and operator	Sadid Inbndustrial Group	160-161
	Turbine 42 MW	TUGA	106-107
	Turbine 159 MW	TUGA	106-107
	Turbine 185 MW	TUGA	106-107
	Turbine 308 MW	TUGA	106-107
	Gear box (wind turbine & ACC gear box)	TUGA	106-107
	Overhaul, repair & maintenance of Gas & Steam turbines	TUGA	106-107

## Glossary

CLASSIFICATION	PRODUCTS / SERVICES	NAME OF COMPANY	PAGE No.
Turbine	Engineering and Manufacturing of all type of Gas and Steam turbines blades, compressor blades for all type of Gas and Steam turbines	TUGA	106-107
	Turbine 25 MW	TUGA	106-107
	Turbine Avon 1535 (refurbishment & spare parts)	TUGA	106-107
Valve	Butterfly valve wafer type & flange type	Farab	50-51
	Globe valve	Farab	50-51
	Gate valve	Farab	50-51
	Check valve	Farab	50-51
	Manual balancing valve	Farab	50-51
	PIBCV-Pressure independent ballancing control valve	Farab	50-51
	Rotery valves	Hava Filter	68-69
	X mass tree and tubing head spool	Machine Sazi Arak Knowledge Base company	94-95
	Control chock valve 2"-10"	Rasta Group	154-155
	Ball valve 1/2"-12"	Rasta Group	154-155
	Butterfly valve 3"-64"	Rasta Group	154-155
	"D" Diaphragm and spring AC tuauors	Rasta Group	154-155
	Control vvalve 1"-24"	Rasta Group	154-155
	Glob control valve 1"-24"	Rasta Group	154-155
	Spring cylinder actuator	Rasta Group	154-155
	Diaphragm and spring actuator	Rasta Group	154-155
	P.O.P	Rasta Group	154-155
Water Treatment	Water treatment (RO, Thermal Desalination)	Azarab Industries Co.	28-29
	Oily water treatment package	Chamman Engineering and Fabrication	34-35
	Water treatment plant	Industrial Pioneers Faraynd	72-73
	Water Treatment Package	Mapna Boiler & Equipment Engineering and Manufacturing	102-103
	Municipal waste processing	Niroumoharekeh Machine Tools Co.	116-117
	Water Softener	Packman	120-121
	Water softener	Pakfanbokhar	122-123
	Sampling System / Steam and Water Analysis System	Piramoons System Qeshm	142-143
	Water Treatment Package	Production Picture Of Iran	146-147
	Pool, water and wastewater treatment plants	Rased Sanat Toseae	156-157



## Guide of Other SATSA Members

Name of Company	Page
Absun Palayesh	210
Dalinfo	210
Eshteal Arak	210
Fakoor Sanat Tehran Engineering Co. (FST)	210
Fangenerator	211
Farabard Shiraz	211
Farapax Shiraz	211
Farassan	211
Havayar Industrial Group	212
Iran Industrial Pumps	212
Iran Industrial Vibrations	212
Iran International Engineering Company (IRITEC)	212
Kalaye Pump Co.	213
Kousha Metal Industries Company (KMI)	213
Mapna Generator Engineering & Manufacturing Co. (Pars)	213
Mashad Sadra Shargh	213
Mirab Valves Co.	214
Mojan Engineering Co.	214
Nik Hvas & Refrigeration	214
Oil Turbo Compressor Construction Co.	214
Pargasiran	215
Pars Foolad Jonoob	215
partosanat	215
Petrosakht Chelsoton Co.	215
Pich Eshpil Iran Co.	216
Sabaniroo	216
Sanco	216
Steam Industrial & Engineering Co.	216
Tabarestan Steel Foundry (T.S.F)	217
Tamkar Industrial Co.	217
Tarhnegash	217
Turbo Compressor Manufacturing Co. (TCMFG)	217
Yazd GHadir (Industrial Turbines Co.)	218
Yekta Andish Sazeh	218
Zolal Iran Co.	218

## Other SATSA Members





### Absun Palayesh

[www.absunpalayesh.com](http://www.absunpalayesh.com)



### Dalinco

[www.dalinco.com](http://www.dalinco.com)



### Fangenerator

[www.fangenerator.com](http://www.fangenerator.com)



### Farabard Shiraz

[www.farabard.ir](http://www.farabard.ir)



### Eshteal Arak

[www.eshteal-arak.com](http://www.eshteal-arak.com)



### Fakoor Sanat Tehran Engineering Co. (FST)

[www.fstco.com](http://www.fstco.com)



### Farapax Shiraz

[www.farapax-shiraz.com](http://www.farapax-shiraz.com)



### Farassan

[www.farassan.com](http://www.farassan.com)



**Havayar Industrial  
Group**

[www.havayar.com](http://www.havayar.com)



**Iran Industrial  
Pumps**

[www.iip-co.com](http://www.iip-co.com)



**Kalaye Pump Co.**

[www.kalayepump.com](http://www.kalayepump.com)



**Kousha Metal  
Industries  
Company (KMI)**

[www.koushametal.ir](http://www.koushametal.ir)



**Iran Industrial  
Vibrations**

[www.livco.org](http://www.livco.org)



**Iran International  
Engineering  
Company (IRITEC)**

[www.iritec.com](http://www.iritec.com)



**Mapna Generator  
Engineering &  
Manufacturing Co.  
(Pars)**

[www.mapnagenerator.com](http://www.mapnagenerator.com)



**Mashad Sadra  
SHargh**

[www.mashadsadrashargh.com](http://www.mashadsadrashargh.com)



**Mirab Valves Co.**

[www.mirab-valves.com](http://www.mirab-valves.com)



**Mojan  
Engineering Co.**

[www.mojan.ir](http://www.mojan.ir)



**Pargasiran**

[www.pargasiran.com](http://www.pargasiran.com)



**Pars Foolad Jonoob**

[www.pfj.co.ir](http://www.pfj.co.ir)



**Nik Hvas &  
Refrigeration**

[www.nikbh.com](http://www.nikbh.com)



**Oil Turbo  
Compressor  
Construction Co.**

[www.otec-co.com](http://www.otec-co.com)



**Partosanat**

[www.partosanat.com](http://www.partosanat.com)



**Petrosakht  
Chelsoton Co.**

[www.petrosakht.com](http://www.petrosakht.com)



**Pich Eshpil Iran Co.**

[www.pei.ir](http://www.pei.ir)



**Sabaniroo**

[www.sabaniroo.co.ir](http://www.sabaniroo.co.ir)



**Tabarestan Steel  
Foundry (T.S.F)**

[www.tsfco.com](http://www.tsfco.com)



**Tamkar  
Industrial Co.**

[www.tamkar.com](http://www.tamkar.com)



**SANCO**

[www.sanco.ir](http://www.sanco.ir)



**STEAM Industrial  
& Engineering Co.**

[www.steam.co.ir](http://www.steam.co.ir)



**Tarhnegasht**

[www.tarhnegasht.com](http://www.tarhnegasht.com)



**Turbo Compressor  
Manufacturing Co.  
(TCMFG)**

[www.tcmfg-co.com](http://www.tcmfg-co.com)



**Yazd GHadir  
Industrial Turbines Co.**

[www.persian.gitco.ir](http://www.persian.gitco.ir)



**Yekta Andish Sazeh**

[www.yas-co.com](http://www.yas-co.com)



**Zolal Iran Co.**

[www.zolal-iran.com](http://www.zolal-iran.com)



**Iranian Industrial Equipment  
Manufacturers Association (SATSA)**

Address: 6 East Floor, No 102, Karimkhan Zand Blvd, Tehran, Iran

Tel: +98 21 88342600, +98 21 88348113 Fax: +98 21 88345639

Web: [www.satsa.ir](http://www.satsa.ir)

Email: [info@satsa.ir](mailto:info@satsa.ir)